



Maretti Lighting
Bolderweg 7

1332 AX Almere
the Netherlands

T +31 (0) 36 532 66 12
F +31 (0) 36 532 17 35

E info@maretti.com
W www.maretti.com

Maretti Lighting is well-known in the World of interior design. In businesses, homes, store chains, and hospitality facilities all over the world, Maretti is unmistakable present with its project lighting that does more than just provide light. We make lighting an essential part of the interior. Maretti stands for stylish top quality and trendsetting design, modern, timeless and most of all, original.

Maretti Lighting works with all the top brands in the lighting industry, but we are especially notable for our own large product line and introduce our own brand name "Maretti". Our production team distinguishes itself time and time again with unique innovations from our own atelier and therefore our projects exude an entirely unique identity.

© Copyright Maretti Projectverlichting.

Our IM was made with the greatest of care. Nevertheless, the colours displayed in the IM may differ slightly from the real colours because of the printing process. Colour, size and range are subject to change. Nothing from this IM may be copied, reproduced and/or published by print, photocopy or in any other way without Maretti Lighting's written permission. All product and design copyrights belong to Maretti Lighting.

GUARANTEE TERMS AND CONDITIONS

The other party should inspect the delivered items immediately upon receipt with regard to its soundness. Entitlements to repair or replacement only exist if the other party

- In the case of visible defects, informs MPV of them immediately.

- In the case of defects that are not visible, informs MPV in writing of the defects, within 2 working days after the day the defects were found, or in all reason could have been found and furthermore demonstrates that the MPV instructions for use, maintenance and operation were followed, whilst the defects are not the consequence of normal wear and tear, misuse, negligence, accident, exceeding the limits prescribed by the MPV or by the legal safety regulations, or, in the case of a repair or change without MPV's consent or the consent of its recognised repairer, there will be no entitlement to repairs or replacement. The parts that have to be replaced must be made available free of charge to MPV. Noncompliance by the other party to one or more of its obligations will release MPV of all its guarantee obligations. In the case of assembly of the other party's own products by Maretti, MPV will release itself from all guarantee stipulations.

Moreover, our general delivery terms and conditions are applicable. These can be obtained from Maretti or can be downloaded from www.maretti.com

The installation must be done by a competent installer. Maretti recommends that your (outside) lighting and fixtures are inspected and maintained annually.

D: Für Garantiebedingungen bitte lesen Sie unsere Webseite www.maretti.com
E: Consulte nuestro sitio web para los condiciones de garantía www.maretti.com
FR: Consultez notre site web pour les conditions de garantie www.maretti.com
NL: Voor garantievoorwaarden zie onze website www.maretti.com

19.8615.34*

MIX LED RGB+WARM WHITE



IP67

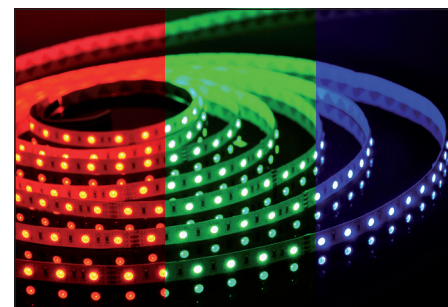

RGB

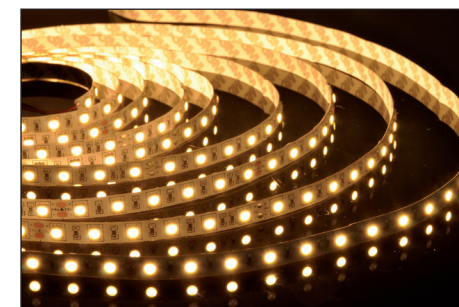

2700 K

GENERAL INFORMATION									
24 VDC	VOLTAGE	IP20	IP RATING	Ra90	CRI	100%	1000H LUMEN MAINTENANCE	CE	CE MARK
	LED INCL.		DRIVER EXCL.	3	SDCM	30.000 hours	LIFETIME LED		
	OUTDOOR		PROFILE NOT INCL.		120°	DEGREE BEAM ANGLE	-20°C ~ 60°C	ENVIRON. TEMPERATURE	











*MIX LED	Cutting size	Colour LED	Kelvin	LED/m	Article number
72W 5000x12mm	100mm	RGB+Warm white (927)	2700	60	19.8615.34

MIX LED RGB+WARM WHITE

INSTRUCTIONS

Installatie voorbeeld

Installation example

	Rood = Rood		Red = Red
	Groen = Groen		Green = Green
	Blauw = Blauw		Blue = Blue
	Zwart = +		Black = +
	Wit = Wit		White = White

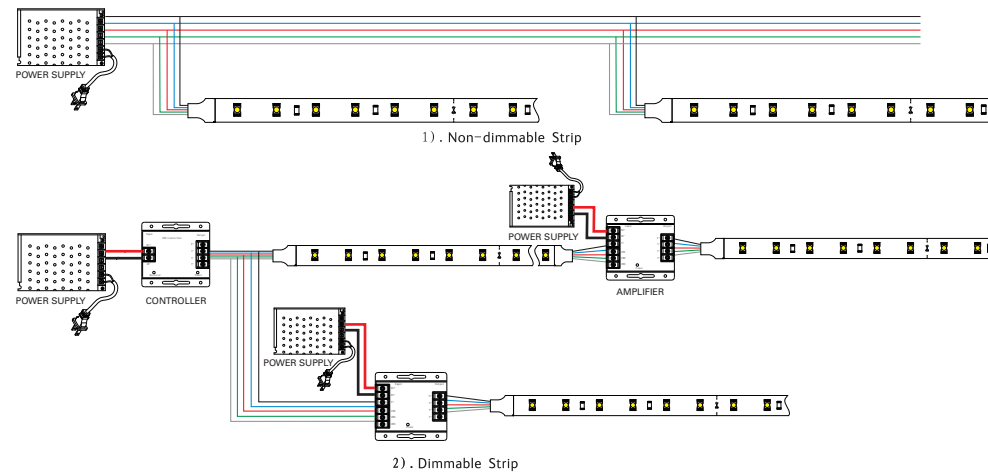

Note: Profiles, opal covers and end caps are ordered separately. **Opmerking:** De accessoires zijn apart te bestellen.

The LED strip must be mounted on an aluminum profile due to heat dissipation.

Peel off the tape backing so you can stick the LED strip on an aluminium profile.

De led strip moet op een aluminium profiel gemonteerd worden i.v.m. warmte afvoer.

Haal het papier van de plakband eraf om de LED strip op een aluminium profiel te kunnen plakken.

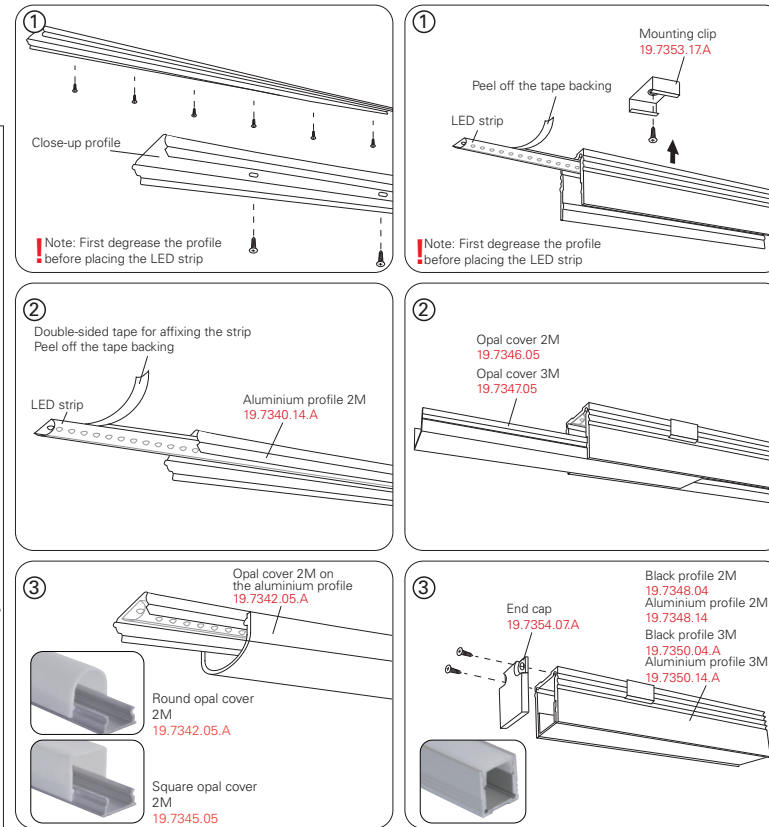

Montage instructies:

- Zorg te allen tijde dat alle spanning is afgesloten.
- LED strip is voorzien van zelfklevende warmte transporterende tape. Om deze LED tape te kunnen verlijmen moet de ondergrond goed schoon en vetvrij zijn.
- Er moet voldoende koeling en luchtcirculatie aanwezig zijn, het monteren op een aluminium strip of warmtegeleidend materiaal is noodzakelijk. (De led strip moet op een aluminium profiel gemonteerd worden i.v.m. warmte afvoer.). Haal A.U.B. het papier van de plakband eraf om de LED strip op een aluminium profiel te kunnen plakken.
- De LED strip is in te korten maar alleen op de aangegeven knijplijn, dit ter voorkoming van kortsluiting. Na het inkorten dient deze dan wel geïsoleerd te worden. Dit geldt ook na solderen van de strip.
- LED strip mag eenmalig gebogen worden, echter NIET op de plekken waar de elektronica componenten zich bevinden.
- De LED strip mag enkel gesoldeerd worden op de daarvoor bestemde contactdelen, naast de inkortposities.
- Maximale soldeertemperatuur is 273 graden Celsius. De MAXIMALE verhittingstijd is 8 seconden.

Extra attentiepunten:

- De elektronica componenten op de LED strip mogen mechanisch NIET belast of afgeklemd worden.
- Let op dat de LED strip bij montage NIET beschadigd of onderbroken wordt.
- LED strip mag alleen parallel geschakeld worden; serieschakeling kan een asymmetrische spanningsverdeling op de module veroorzaken, waardoor er overbelasting ontstaat die kan leiden tot een defect.
- De voedingsbron dient van voldoende vermogen te zijn voor de aangesloten LED strip.
- Montage dient te geschieden volgens de ESD normen (Elektrostatische Ontlading). Bij het niet in acht nemen van deze normen kan er een defect ontstaan in de LED strip.
- Bij montage in vochtige, stoffige en vuile inbouw gelegenheden dient er voldoende maatregelen genomen te worden om eventuele inwerking hiervan op de LED strip tegen te gaan.
- Beschermende en isolerende materialen die toegepast worden bij montage dienen een goede lichttransmissie te hebben, UV-stabiel te zijn, bestand te zijn tegen temperatuurschommelingen en tegen corrosieve atmosferische omstandigheden.
- LED strip dient uitsluitend gemonteerd te worden door elektrisch geschoold personeel, die de installatie van de LED strip volgens de daartoe geldende richtlijnen en normen uitvoert.
- Reiniging en onderhoud van de LED strip mag alleen met droge doek en NOOIT met vloeibare en/of schuurmiddelen. Als het toch nat/vochtig is geworden dan direct de installatie spanningloos maken en alles droog maken.

Maretti Projectverlichting BV. is niet aansprakelijk voor enige schade, ontstaan door foutief gebruik of verkeerde installatie van de LED strip. Tevens vervalt de garantie als een van deze punten niet wordt nageleefd.

*No rights can be derived from the information provided on this Instruction Manual. Information on the Instruction Manual has been compiled with the utmost care and is updated on a continuous basis. Nevertheless Maretti cannot guarantee that all information is free of errors, complete or fully up to date."

Installation instructions:

- Ensure at all times that all power is shut down.
- LED strip is supplied with self-adhesive heat-transporing tape. To bond this LED tape, the surface must be clean and free of grease.
- It's important to provide sufficient cooling and air circulation. Mounting on an aluminium strip or heat conductive material is necessary. (The LED strip must be mounted on an aluminium profile due to heat dissipation.). Don't forget to peel off the tape backing so you can stick the LED strip on an aluminium profile.
- To prevent short circuit the LED strip can only be shortened at the indicated cutting lines, and if cut there it needs to be insulated. Also after soldering the strip, it needs to be insulated.
- LED strip can be bent only once and NOT on the places where the electronic components are located.
- The LED strip can only be soldered to the appropriate contact parts, besides the cutting lines.
- Maximum soldering temperature is 273 degrees Celsius. MAXIMUM duration of heating is 8 seconds.

Additional cautions:

- The electronic components on the LED strip should NOT be burdened or clamped in any mechanical way.
- Make sure that the LED strip is NOT damaged or obstructed during assembly.
- LED strip may only be connected in parallel; series connection can cause an asymmetric voltage distribution on the module, thereby providing an overload, which may lead to a malfunction.
- The power source must have sufficient power for the connected LED strip.
- Installation must be carried out according to the ESD standards (Electrostatic Discharge). Not working according to these standards may cause a malfunction in the LED strip.
- When installing into damp, dusty and dirty mounting spaces, adequate measures should be taken to make sure these circumstances don't affect the LED strip.
- Protective and insulating materials that are used in assembly should have a good light transmission, be UV-stable and be resistant to changes in temperature and atmospheric corrosive conditions.
- LED strip should only be installed by trained personnel, executing the installation of the LED strip in accordance with the applicable directives and standards.
- Cleaning and maintenance of the LED strip is only allowed with dry cloth and NEVER with liquid and/or abrasives. If the LED strip does get wet or damp, immediately disconnect the power of the LED strip and dry all components.

Maretti Project Lighting BV. is not liable for any damage caused by misuse or incorrect installation of the LED strip. Also the warranty will be invalid if any of these points are not respected.

CAUTIONS

INSTRUCTIONS



Let bij het plaatsen van de ledstrip op de installatietechniek. De ledstrip kan worden gebogen, maar niet vervormd, zoals hieronder weergegeven:

When install the LED strip, please note the installation technique. The LED strip can be bent, but not distorted, as shown below:

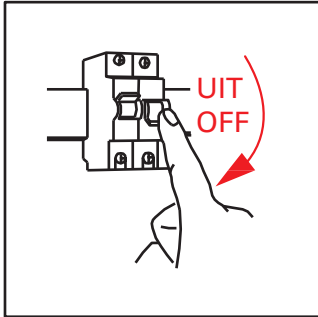

Schakel altijd eerst de stroom uit voordat u installatie-, onderhoud of reparatie-werkzaamheden uitvoert.

Always switch off the mains voltage before carrying out installation, maintenance and repair work.

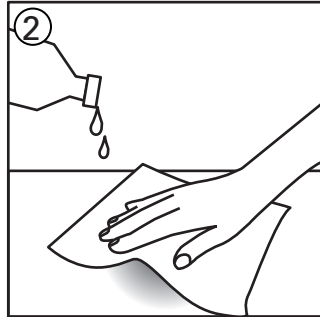

De plek voor de LED-strip moet vetvrij, droog, vlak en glad zijn voordat u de LED-strips aanbrengt.

The place for the LED strip should be fat-free, dry, flat and smooth before applying the LED strips.

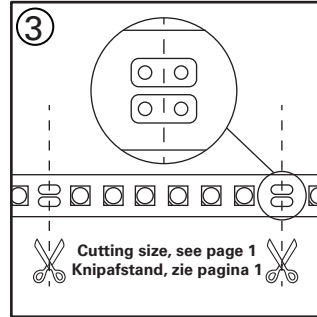

LED-strip kan alleen op de stippellijnen tussen soldeer pads worden geknipt.

LED strip can only be cut on the dotted lines between solder pads.

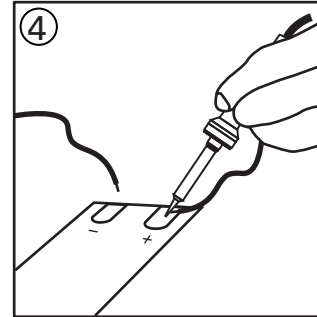

Soldeer draden op soldeer pads (label +/-). De soldeertemperatuur mag niet hoger zijn dan 350°C voor een maximale duur van max. 3 seconden.

Solder wires on solder pads (label +/-). The soldering temperature must not exceed 350°C for a maximum duration of max. 3 seconds.

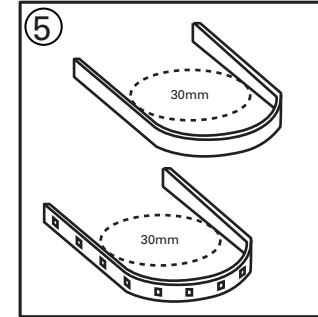

LED-strips zijn buigbaar. Max. buigradius is 30mm.

LED strips are bendable. Max. bending radius is 30mm.

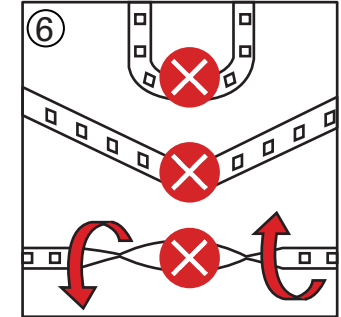

LED-strips kunnen niet worden gebogen of gedraaid in de gedemonstreerde richtingen.

LED strips can not be bent or twisted in the demonstrated directions.

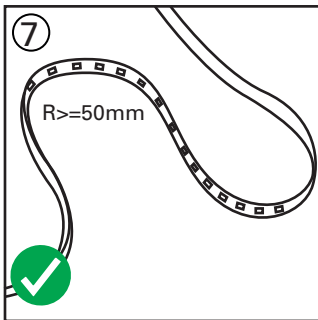

Buigende diameter

Bending diameter

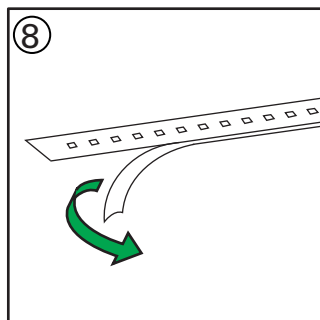

Verwijder het plakband op de achterkant van de LED-strip tijdens het vastplakken van de LED-strip

Remove the adhesive tape on the back side of the LED strip.

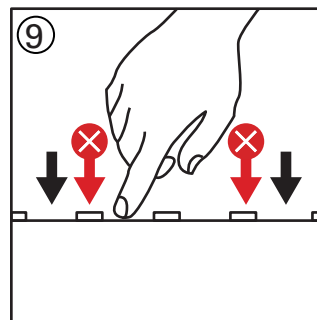

Druk voorzichtig op de LED-strip tussen elektronische componenten. Druk niet op elektronische componenten.

Press the LED strip gently between electronic components to stick it to the surface. Avoid pressing electronic components.

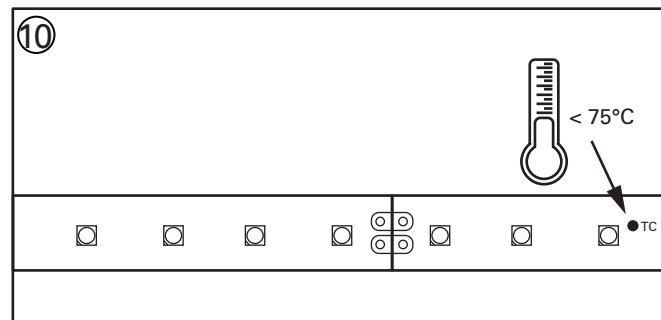

LED-strips moeten worden geïnstalleerd op aluminium (of materiaal met vergelijkbare thermische geleiding) om te voorkomen dat LED's oververhit raken en zorgen voor een goede warmteafvoer. Meet de TC-temperatuur na 30 min. tijdens gebruik. De TC-temperatuur mag niet hoger zijn dan 75°C.

LED strips must be installed on aluminum (or material with comparable thermal conductivity) to prevent LEDs from overheating and ensure proper heat dissipation. Measure the TC temperature after 30 min. during use. The TC temperature should not exceed 75°C.

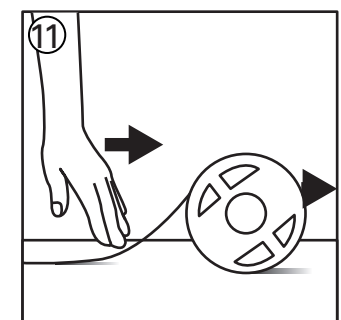

Houd de LED-strip op de haspel terwijl u deze op het oppervlak aanbrengt. Verwijder het plakband en breng de tape aan terwijl u de haspel tegelijkertijd uitrolt.

Keep the LED strip on the reel while you apply it to the surface. Remove the adhesive tape and apply the tape while unrolling the reel at the same time.

- LED-strips zijn laagspanningsproducten, u moet een voeding (transformator) gebruiken.
- Sluit de ledstrip a.u.b. niet rechtstreeks aan op AC 110V of AC 220V, anders zullen de ledstrips doorbranden

- LED strips are low voltage products, you must use a power supply (transformer).
- Please do not connect the LED strip directly to the AC 110V or AC 220V, otherwise it will burn out the LED strips.

- Reinig het installatieoppervlak, dit zorgt voor de betrouwbaarheid van de lijm.
- Het elektrische aansluitproces moet worden uitgevoerd door een professionele persoon.

- Clean up the installation surface, it will ensure the reliability of the adhesive.
- The electrical connection process must be operated by a professional person.

*No rights can be derived from the information provided on this Instruction Manual. Information on the Instruction Manual has been compiled with the utmost care and is updated on a continuous basis. Nevertheless Maretti cannot guarantee that all information is free of errors, complete or fully up to date."