



Maretti Lighting
Bolderweg 7

1332 AX Almere
the Netherlands

T +31 (0) 36 532 66 12
F +31 (0) 36 532 17 35

E info@maretti.com
W www.maretti.com

Maretti Lighting is well-known in the World of interior design. In businesses, homes, store chains, and hospitality facilities all over the world, Maretti is unmistakable present with its project lighting that does more than just provide light. We make lighting an essential part of the interior. Maretti stands for stylish top quality and trendsetting design, modern, timeless and most of all, original.

Maretti Lighting works with all the top brands in the lighting industry, but we are especially notable for our own large product line and introduce our own brand name "Maretti". Our production team distinguishes itself time and time again with unique innovations from our own atelier and therefore our projects exude an entirely unique identity.

© Copyright Maretti Projectverlichting.

Our IM was made with the greatest of care. Nevertheless, the colours displayed in the IM may differ slightly from the real colours because of the printing process. Colour, size and range are subject to change. Nothing from this IM may be copied, reproduced and/or published by print, photocopy or in any other way without Maretti Lighting's written permission. All product and design copyrights belong to Maretti Lighting.

GUARANTEE TERMS AND CONDITIONS

The other party should inspect the delivered items immediately upon receipt with regard to its soundness. Entitlements to repair or replacement only exist if the other party

- In the case of visible defects, informs MPV of them immediately.

- In the case of defects that are not visible, informs MPV in writing of the defects, within 2 working days after the day the defects were found, or in all reason could have been found and furthermore demonstrates that the MPV instructions for use, maintenance and operation were followed, whilst the defects are not the consequence of normal wear and tear, misuse, negligence, accident, exceeding the limits prescribed by the MPV or by the legal safety regulations, or, in the case of a repair or change without MPV's consent or the consent of its recognised repairer, there will be no entitlement to repairs or replacement. The parts that have to be replaced must be made available free of charge to MPV. Noncompliance by the other party to one or more of its obligations will release MPV of all its guarantee obligations.

In the case of assembly of the other party's own products by Maretti, MPV will release itself from all guarantee stipulations. Moreover, our general delivery terms and conditions are applicable. These can be obtained from Maretti or can be downloaded from www.maretti.com

The installation must be done by a competent installer. Maretti recommends that your (outside) lighting and fixtures are inspected and maintained annually.

D: Für Garantiebedingungen bitte lesen Sie unsere Webseite www.maretti.com
E: Consulte nuestro sitio web para los condiciones de garantía www.maretti.com
FR: Consultez notre site web pour les conditions de garantie www.maretti.com
NL: Voor garantievoorwaarden zie onze website www.maretti.com

19.7380.COLOUR

SHELF-LED UP/DOWN 3M

ACCESSORIES (SEE PAGE 2)

THEY ARE ORDERED SEPARATELY



BLACK

04

max. 10W p/m	WATTAGE PER METER	3M	LENGTH	CE	CE MARK		
IP20	IP RATING	120°	BEAM ANGLE				
	INDOOR	LED STRIP	NOT INCLUDED				

SHELF-LED UP/DOWN 3M

INSTRUCTIONS

SHELF-LED UP/DOWN (LED EXCL.)

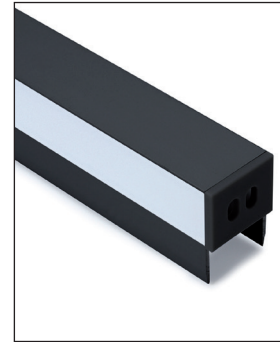
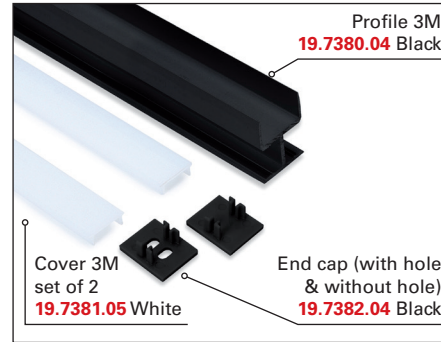
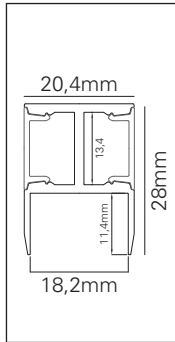
**ACCESSORIES (ORDERED SEPARATELY)**

19.7381.05	SHELF-LED UP/DOWN COVER 3M SET OF 2, WHITE
19.7382.04	SHELF-LED UP/DOWN END CAP (with hole and without hole), BLACK

LED STRIPS (ORDERED SEPARATELY)

19.8401.82	FLASH LED 24W 24V IP20 RA90 5000x8mm 2700K 380 lm/m
-------------------	---

LED STRIPS (ORDERED SEPARATELY)

16.9752.2403	LED DRIVER 24VDC 30W LEADING/TRAILING EDGE DIM.
16.9752.2407	LED DRIVER 24VDC 75W LEADING/TRAILING EDGE DIM.
16.94101.2405.00	LED DRIVER DALI 24VDC 50W DALI DIM. 1-2 CH

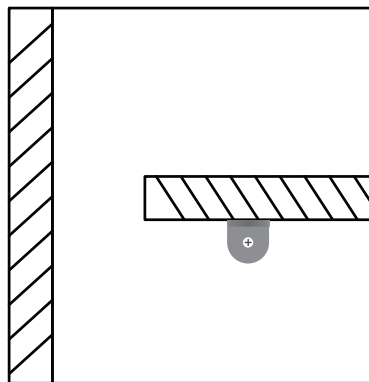

Move the wooden panel forward and fix, to reserve space for LED profile.

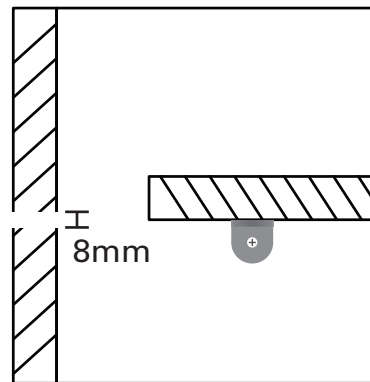

Drill a $\varnothing 8\text{mm}$ (recommendatory) hole in the backside of the furniture, to allow power supply cable to go through.

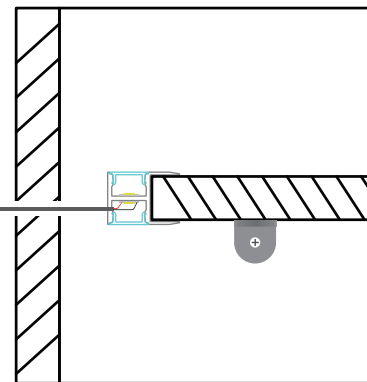

Install LED light on the wooden panel. Connect power supply with the wooden panel LED profile.

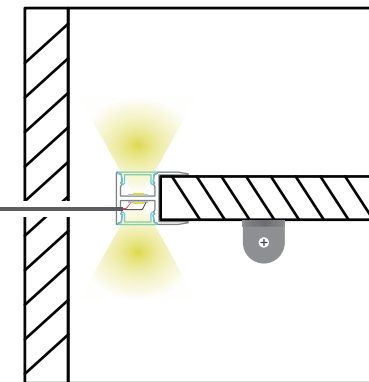

Turn on the power and light is ON.

**LET OP:**

- Volg en bewaar deze gebruiksaanwijzing.
- Zorg ervoor dat de netspanning uitgeschakeld is voor installatie, reparatie of onderhoud. (Installatie, reparatie en onderhoud uitsluitend door gekwalificeerde personen).
- Voor reparatie of onderhoud uitsluitend originele delen gebruiken.
- Gebruik het armatuur alleen binnenshuis.
- Het armatuur niet in vochtige of natte ruimte gebruiken.

De fabrikant aanvaardt geen enkele aansprakelijkheid voor letsel of schade als gevolg van een verkeerde toepassing van het armatuur. De fabrikant aanvaardt geen garantie in geval van het niet behandelen van de lampen volgens de richtlijnen van de fabrikant. Als er schade aan elektrische onderdelen te vinden zijn, vraag dan een elektricien om het te vervangen.

Onderhoud is behoud:

Een goede instandhouding van het armatuur is sterk afhankelijk van omgevings- en onderhoudsfactoren. Hierop kunnen wij geen invloed uitoefenen.

- Schakel voor de zekerheid de elektriciteit uit!
- Gebruik geen bijtende, chemische of schurende schoonmaakmiddelen.

NOTE:

- Follow and keep this instructions manual.
- Make sure that the mains voltage is switched off for installation, repair or maintenance. (Installation, repair and maintenance only by qualified persons).
- Use only original parts for repairs or maintenance.
- Use the fixture only indoors.
- Don't use the fixture in humid or wet areas.

The manufacturer accepts no liability for any injuries or damages resulting from the incorrect use or installation of the fixture. Any operation performed on the fixture that is not in accordance with instructions will void manufacturer's warranty. If you find any damage to the electrical parts, please ask a qualified electrician to replace it.

Maintenance is preservation:

A good preservation of the fixture is highly dependent on environmental factors and maintenance. We cannot exercise any influence on this.

- Make sure that the mains voltage is switched off before you begin.
- Do not use strong, chemicals or abrasive cleaners.

"No rights can be derived from the information provided on this Instruction Manual. Information on the Instruction Manual has been compiled with the utmost care and is updated on a continuous basis. Nevertheless Maretti cannot guarantee that all information is free of errors, complete or fully up to date."