



Maretti Lighting  
Bolderweg 7

1332 AX Almere  
the Netherlands

T +31 (0) 36 532 66 12

E info@maretti.com  
W www.maretti.com

Maretti Lighting is well-known in the World of interior design. In businesses, homes, store chains, and hospitality facilities all over the world, Maretti is unmistakable present with its project lighting that does more than just provide light. We make lighting an essential part of the interior. Maretti stands for stylish top quality and trendsetting design, modern, timeless and most of all, original.

Maretti Lighting works with all the top brands in the lighting industry, but we are especially notable for our own large product line and introduce our own brand name "Maretti". Our production team distinguishes itself time and time again with unique innovations from our own atelier and therefore our projects exude an entirely unique identity.

© Copyright Maretti Projectverlichting.

Our IM was made with the greatest of care. Nevertheless, the colours displayed in the IM may differ slightly from the real colours because of the printing process. Colour, size and range are subject to change. Nothing from this IM may be copied, reproduced and/or published by print, photocopy or in any other way without Maretti Lighting's written permission. All product and design copyrights belong to Maretti Lighting.

#### GUARANTEE TERMS AND CONDITIONS

The other party should inspect the delivered items immediately upon receipt with regard to its soundness. Entitlements to repair or replacement only exist if the other party

- In the case of visible defects, informs MPV of them immediately.

- In the case of defects that are not visible, informs MPV in writing of the defects, within 2 working days after the day the defects were found, or in all reason could have been found and furthermore demonstrates that the MPV instructions for use, maintenance and operation were followed, whilst the defects are not the consequence of normal wear and tear, misuse, negligence, accident, exceeding the limits prescribed by the MPV or by the legal safety regulations, or, in the case of a repair or change without MPV's consent or the consent of its recognised repairer, there will be no entitlement to repairs or replacement. The parts that have to be replaced must be made available free of charge to MPV. Noncompliance by the other party to one or more of its obligations will release MPV of all its guarantee obligations. In the case of assembly of the other party's own products by Maretti, MPV will release itself from all guarantee stipulations.

Moreover, our general delivery terms and conditions are applicable. These can be obtained from Maretti or can be downloaded from [www.maretti.com](http://www.maretti.com)

The installation must be done by a competent installer. Maretti recommends that your (outside) lighting and fixtures are inspected and maintained annually.

D: Für Garantiebedingungen bitte lesen Sie unsere Webseite [www.maretti.com](http://www.maretti.com)  
E: Consulte nuestro sitio web para los condiciones de garantía [www.maretti.com](http://www.maretti.com)  
FR: Consultez notre site web pour les conditions de garantie [www.maretti.com](http://www.maretti.com)  
NL: Voor garantievoorwaarden zie onze website [www.maretti.com](http://www.maretti.com)

14.1806.COLOUR  
14.1815.COLOUR

## STRETTO LED FRONT







HORIZONTAL / VERTICAL

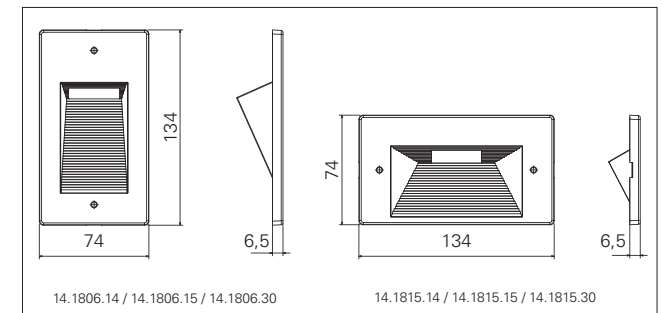

14.1806 (Vertical)

14.1815 (Horizontal)



230V	VOLTAGE		NOT DIMMABLE		OUTDOOR		F-MARK
4,5W	WATTAGE	Ra 85	CRI	IP65	IP RATING		CE MARK
	DRIVER INCLUDED	168 lm	LUMEN	10	IK RATING		
	LED BULB INCLUDED	3000K	KELVIN		CLASS II		

DIT PRODUCT BEVAT EEN LICHTBRON VAN ENERGIE-EFFICIËNTIEKLASSE: G  
THIS PRODUCT CONTAINS A LIGHT SOURCE OF ENERGY EFFICIENCY CLASS: G

14.1806.COLOUR

14.1815.COLOUR

# STRETTO LED FRONT

## VERTICAL / HORIZONTAL

### INSTRUCTIONS

**WARNING:** This lighting fitting is installed in wet location IP65 only if installed on a backbox 14.1800.00 (separate order)

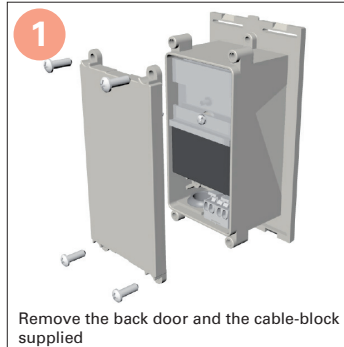

Remove the back door and the cable-block supplied

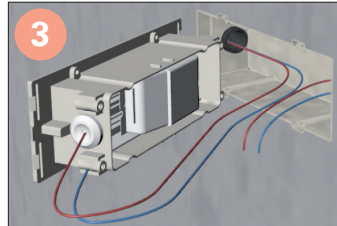
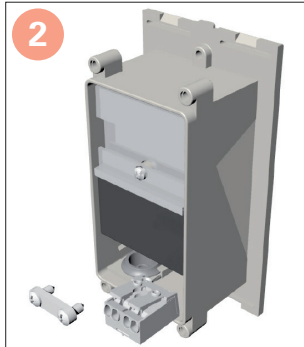

Insert the power conductors through the membrane cable entry and connect to the pushwire terminal block. In case of through wiring installation use the two cable entry / each terminal

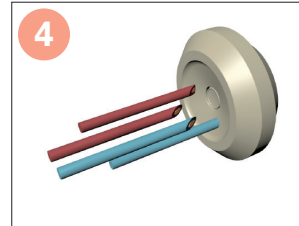

Operate in order to keep the membrane around the cable towards out

14.1812.00 Stretto LED body horizontal

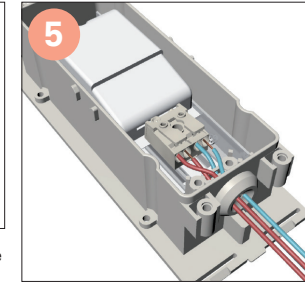

14.1802.00 Stretto LED body vertical

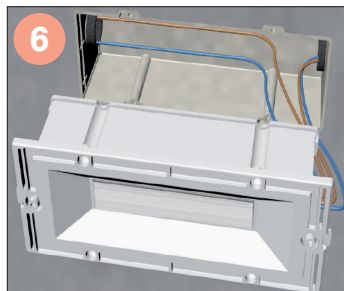
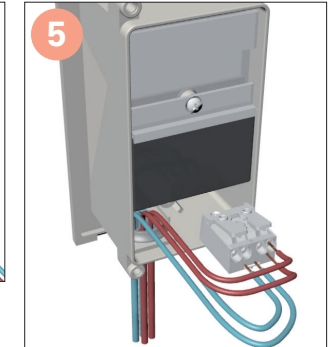

Close the back-door and insert the light body in the back-box. Pay attention to relocate the wiring inside

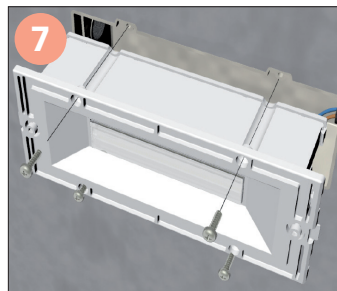
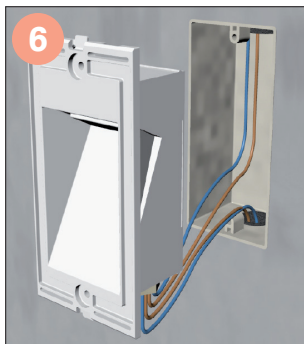

Block the external mask and the light body to the back-box

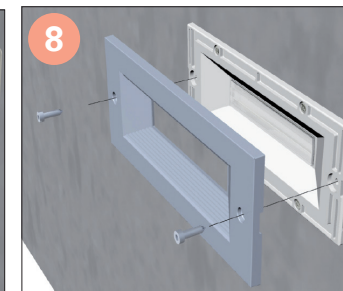
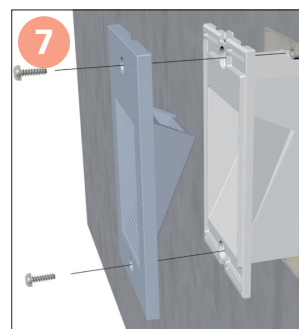

IP65 index is guaranteed only if the back-box is completely in line with the surface of the wall. If it's not so, you can use the additional gasket supplied, in order to compensate the level difference

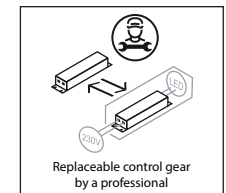
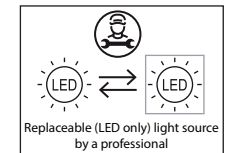

**LET OP:** Volg en bewaar deze gebruiksaanwijzing.

- Zorg ervoor dat de netspanning uitgeschakeld is voor installatie, reparatie of onderhoud. (Installatie, reparatie en onderhoud uitsluitend door gekwalificeerde personen).
- Voor reparatie of onderhoud uitsluitend originele delen gebruiken. Probeer het product niet zelf te demonteren en te repareren, onjuiste reparaties kunnen het product beschadigen en elektrische schokken veroorzaken wat tot ernstig letsel kan leiden.
- Om waterdichtheid te verzekeren dient u alle onderdelen handvast aan te draaien.
- Dit armatuur niet openen of installeren tijdens regen of hoge luchtvochtigheid.
- Uitsluitend op het etiket aangegeven lichtbronnen gebruiken.

De fabrikant aanvaardt geen enkele aansprakelijkheid voor letsel of schade als gevolg van een verkeerde toepassing van het armatuur. De fabrikant aanvaardt geen garantie in geval van het niet behandelen van de lampen volgens de richtlijnen van de fabrikant. Als er schade aan elektrische onderdelen te vinden zijn, vraag dan een electricien om het te vervangen.

**Onderhoud is behoud:**

- Een goede instandhouding van het armatuur is sterk afhankelijk van omgevings- en onderhoudsfactoren. Hierop kunnen wij geen invloed uitoefenen. Alle producten hebben onderhoud nodig, zo ook uw buitenlamp.
- Schakel voor de zekerheid de elektriciteit uit!
- Wij adviseren om 2x per jaar de armaturen te reinigen.
- Gebruik geen agressieve, schurende of chemische schoonmaakmiddelen.
- Aan de directe kuststreek en de Waddeneilanden adviseren we minimaal 1x per kwartaal de buitenlampen te reinigen.
- Goed onderhoud verlengt het plezier en levensduur van uw buitenlampen.

**NOTE:** Follow and keep this instructions manual.

- Make sure that the mains voltage is switched off before installation, repair or maintenance. (Installation, repair and maintenance only by qualified persons).
- Use only original parts for repairs or maintenance. Never attempt to disassemble, repair or alter the product in any way, improper repairs could damage the product causing electrical shocks which may cause serious injury.
- Make sure all parts are turned hand tight to be sure the item is waterproof.
- Do not open or install this luminaire during rain or highly humid condition.
- Use only suitable light sources indicated on the label.

The manufacturer accepts no liability for any injuries or damages resulting from the incorrect use or installation of the fixture. Any operation performed on the fixture that is not in accordance with instructions will void manufacturer's warranty. If you find any damage to the electrical parts, please ask a qualified electrician to replace it.

**Maintenance is preservation:**

- A good preservation of the fixture is highly dependent on environmental factors and maintenance. We cannot exercise any influence on this. All products require maintenance, including your outdoor fixture.
- Make sure that the mains voltage is switched off before you begin.
- We recommend to clean the fixtures 2x per year.
- Do not use aggressive, abrasive or chemical cleaners.
- On the immediate coast and the Wadden Islands we recommend cleaning the outdoor fixtures at least 1x per quarter.
- Proper maintenance extends the pleasure and lifespan of your outdoor fixtures.

"No rights can be derived from the information provided on this Instruction Manual. Information on the Instruction Manual has been compiled with the utmost care and is updated on a continuous basis. Nevertheless Maretti cannot guarantee that all information is free of errors, complete or fully up to date."

14.1806.COLOUR  
14.1815.COLOUR

# STRETTO LED FRONT

## VERTICAL / HORIZONTAL

### INSTRUCTIONS

ACCESSORIES  
SEPARATE ORDER

#### STRETTO ACCESSORIES (SEPARATE ORDER)

Accessories

Article number



- 1 Stretto led backbox (L:145 x W:84 x H:56mm) 14.1800.00
- 2 Stretto led body vertical (L:130 x W:70 x D:49mm) 14.1802.00
- 3 Stretto led body horizontal (L:130 x W:70 x D:49mm) 14.1812.00

Front

Backbox  
separate order

Body  
separate order

Aluminium

Polycarbonate

Stainless  
steel



14.1800.00

14.1802.00

14.1806.14

14.1806.30

14.1806.15

CUTTING DIMENSIONS BACKBOX 14.1800.00 (separate order)

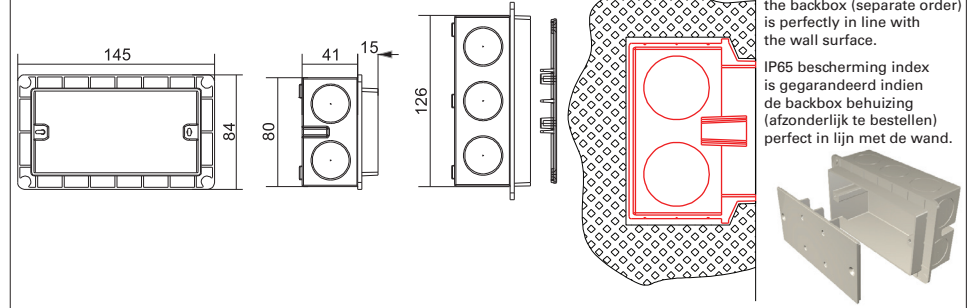

#### \* Stainless steel:

Stainless steel means that the material itself cannot oxidize, but can certainly attract oxidation from the environment.

#### Maintenance

Greasy fingers, dirt, surface damage, sea air and iron dust nearby such highways and railroads or tramway, can damage the oxide layer of stainless steel and corrosion may arise. Good and regular maintenance of the stainless steel is required. We hereby advise to use only special chlorine free stainless steel cleaner. This cleaner forms a protective layer to the stainless steel.

#### Installation

stainless steel has a natural property to create a protective layer. This 3-day process starts after removal of the protective film on the stainless steel. Due to harmful acids to the hands, the protective film can therefore only be removed with gloves. The material is during the process more vulnerable. Avoid therefore the abovementioned environmental factors and the touch, physically or through the air, with other metals. The stainless steel should be, after these 3 days, sprayed with a special chlorine free stainless steel cleaner and mounted with gloves.

#### Warranty

A good preservation of the stainless steel is highly dependent on environmental factors and maintenance. Maretti cannot exercise any influence on this. Therefore unfortunately we cannot give any guarantees that stainless steel does not corrode.



#### LET OP: Volg en bewaar deze gebruiksaanwijzing.

- Zorg ervoor dat de netspanning uitgeschakeld is voor installatie, reparatie of onderhoud. (Installatie, reparatie en onderhoud uitsluitend door gekwalificeerde personen).
- Voor reparatie of onderhoud uitsluitend originele delen gebruiken. Probeer het product niet zelf te demonteren en te repareren, onjuiste reparaties kunnen het product beschadigen en elektrische schokken veroorzaken wat tot ernstig letsel kan leiden.
- Om waterdichtheid te verzekeren dient u alle onderdelen handvast aan te draaien.
- Dit armatuur niet openen of installeren tijdens regen of hoge luchtvochtigheid.
- Uitsluitend op het etiket aangegeven lichtbronnen gebruiken.

De fabrikant aanvaardt geen enkele aansprakelijkheid voor letsel of schade als gevolg van een verkeerde toepassing van het armatuur. De fabrikant aanvaardt geen garantie in geval van het niet behandelen van de lampen volgens de richtlijnen van de fabrikant. Als er schade aan elektrische onderdelen te vinden zijn, vraag dan een electricien om het te vervangen.

#### Onderhoud is behoud:

- Een goede instandhouding van het armatuur is sterk afhankelijk van omgevings- en onderhoudsfactoren. Hierop kunnen wij geen invloed uitoefenen. Alle producten hebben onderhoud nodig, zo ook uw buitenlamp.
- Schakel voor de zekerheid de elektriciteit uit!
- Wij adviseren om 2x per jaar de armaturen te reinigen.
- Gebruik geen agressieve, schurende of chemische schoonmaakmiddelen.
- Aan de directe kuststreek en de Waddeneilanden adviseren we minimaal 1x per kwartaal de buitenlampen te reinigen.
- Goed onderhoud verlengt het plezier en levensduur van uw buitenlampen.

#### NOTE: Follow and keep this instructions manual.

- Make sure that the mains voltage is switched off before installation, repair or maintenance. (Installation, repair and maintenance only by qualified persons).
- Use only original parts for repairs or maintenance. Never attempt to disassemble, repair or alter the product in any way, improper repairs could damage the product causing electrical shocks which may cause serious injury.
- Make sure all parts are turned hand tight to be sure the item is waterproof.
- Do not open or install this luminaire during rain or highly humid condition.
- Use only suitable light sources indicated on the label.

The manufacturer accepts no liability for any injuries or damages resulting from the incorrect use or installation of the fixture. Any operation performed on the fixture that is not in accordance with instructions will void manufacturer's warranty. If you find any damage to the electrical parts, please ask a qualified electrician to replace it.

#### Maintenance is preservation:

- A good preservation of the fixture is highly dependent on environmental factors and maintenance. We cannot exercise any influence on this. All products require maintenance, including your outdoor fixture.
- Make sure that the mains voltage is switched off before you begin.
- We recommend to clean the fixtures 2x per year.
- Do not use aggressive, abrasive or chemical cleaners.
- On the immediate coast and the Wadden Islands we recommend cleaning the outdoor fixtures at least 1x per quarter.
- Proper maintenance extends the pleasure and lifespan of your outdoor fixtures.

"No rights can be derived from the information provided on this Instruction Manual. Information on the Instruction Manual has been compiled with the utmost care and is updated on a continuous basis. Nevertheless Maretti cannot guarantee that all information is free of errors, complete or fully up to date."