



WOLTERINCK
DESIGNING YOUR WORLD



MARETTI
LIGHTING

Maretti Lighting
Bolderweg 7

1332 AX Almere
the Netherlands

T +31 (0) 36 532 66 12

E info@maretti.com
W www.maretti.com

Purity, symmetry and luxury - the unmistakable style of Wolterinck, leading creator of design products. In his style and vision, and in close collaboration with Wolterinck Design, the design teams of Maretti Lighting have developed technically advanced lighting fixtures for the collections 'Special design Wolterinck'.

© Copyright Maretti Projectverlichting.

Our IM was made with the greatest of care. Nevertheless, the colours displayed in the IM may differ slightly from the real colours because of the printing process. Colour, size and range are subject to change. Nothing from this IM may be copied, reproduced and/or published by print, photocopy or in any other way without Maretti Lighting's written permission. All product and design copyrights belong to Maretti Lighting.

GUARANTEE TERMS AND CONDITIONS

The other party should inspect the delivered items immediately upon receipt with regard to its soundness. Entitlements to repair or replacement only exist if the other party

- In the case of visible defects, informs MPV of them immediately.

- In the case of defects that are not visible, informs MPV in writing of the defects, within 2 working days after the day the defects were found, or in all reason could have been found and furthermore demonstrates that the MPV instructions for use, maintenance and operation were followed, whilst the defects are not the consequence of normal wear and tear, misuse, negligence, accident, exceeding the limits prescribed by the MPV or by the legal safety regulations, or, in the case of a repair or change without MPV's consent or the consent of its recognised repairer, there will be no entitlement to repairs or replacement. The parts that have to be replaced must be made available free of charge to MPV. Noncompliance by the other party to one or more of its obligations will release MPV of all its guarantee obligations.

In the case of assembly of the other party's own products by Maretti, MPV will release itself from all guarantee stipulations.

Moreover, our general delivery terms and conditions are applicable. These can be obtained from Maretti or can be downloaded from www.maretti.com

The installation must be done by a competent installer. Maretti recommends that your (outside) lighting and fixtures are inspected and maintained annually.

D: Für Garantiebedingungen bitte lesen Sie unsere Webseite www.maretti.com
E: Consulte nuestro sitio web para los condiciones de garantía www.maretti.com
FR: Consultez notre site web pour les conditions de garantie www.maretti.com
NL: Voor garantievoorwaarden zie onze website www.maretti.com

14.1328.COLOUR.A

| COSTA LATERNA MURAL



BLACK

O4

230V	VOLTAGE		OUTDOOR						
max. 20W	MAX. WATTAGE		IP RATING						
	G9 BULB* INCL.		4 KG						
E27	SOCKET		CE MARK						

*ZIE OMMEZIJDE VOOR MEER INFORMATIE OVER DE LICHTBRON / SEE BACK SIDE FOR MORE INFORMATION ABOUT THE LIGHT SOURCE

LED	Kelvin	Lumen	Article number
 Bonito GU9 2W not DIM.	2800K	180 lm	21.8260.82

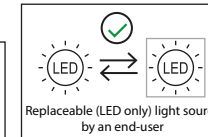

Schakel altijd eerst de stroom uit voordat u installatie-, onderhoud of reparatiewerkzaamheden uitvoert.

Always switch off the mains voltage before carrying out installation, maintenance and repair work.

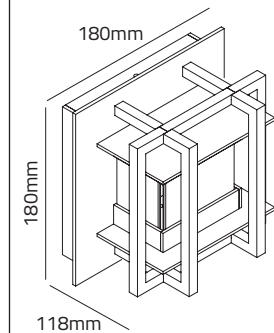

BELANGRIJKE INSTALLATIERICHTLIJNEN VOOR ZWARE ARMATUREN!

- Schakel een professional in**
Voor een veilige en correcte installatie van zware lampen raden wij aan om ALTIJD een ervaren professional in te schakelen.
- Veiligheid eerst**
Een onjuiste installatie kan leiden tot schade, letsel of gevaarlijke situaties. Neem geen risico's en volg de richtlijnen zorgvuldig op.
- Controleer de draagkracht van plafond of wand**
Zorg ervoor dat het plafond of de wand het gewicht van de lamp veilig kan dragen. Laat dit altijd beoordelen door een vakman.
- Gebruik geschikte bevestigingsmaterialen**
Gebruik GEEN standaard pluggen of schroeven. Zorg voor:
 - Sterke bouten en pluggen,
 - Chemische ankers, of
 - Houtfretten (afhankelijk van het materiaal).
 Laat een vakman bepalen welke bevestigingsmaterialen het meest geschikt zijn.
- Controleer het materiaal van plafond of wand**
Het type ondergrond (bijv. beton, hout, gips) bepaalt welke bevestigingsmethoden nodig zijn. Laat een vakman de juiste materialen en montage controleren.
- Voer een jaarlijkse controle uit**
Materialen in plafonds en wanden kunnen na verloop van tijd verouderen of zwakkeren. Laat daarom jaarlijks een vakman de bevestiging en het draagvermogen controleren.

IMPORTANT INSTALLATION GUIDELINES FOR HEAVY FIXTURES!

- Hire a professional**
For safe and correct installation of heavy fixtures, ALWAYS hire an experienced professional.
- Safety first**
Improper installation can cause damage, injury, or hazardous situations. Don't take risks—follow these guidelines carefully.
- Check the load-bearing capacity of the ceiling or wall**
Ensure that the ceiling or wall can safely support the weight of the fixture. Always have this assessed by a professional.
- Use appropriate mounting materials**
NEVER use standard plugs or screws. Instead, use:
 - Strong bolts and plugs,
 - Chemical anchors, or
 - Wood screws (depending on the material).
 Let a professional determine the most suitable mounting materials.
- Check the material of the ceiling or wall**
The type of surface (e.g., concrete, wood, plaster) determines the required mounting methods. Have a professional verify the materials and installation.
- Perform an annual inspection**
Over time, ceiling and wall materials may degrade or weaken. Have a professional inspect the mounting and load-bearing capacity annually.

1. Mounting

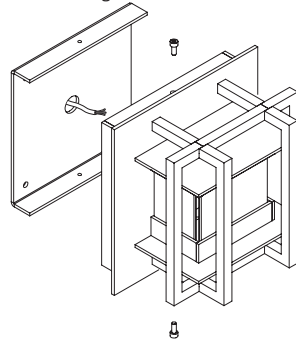

2. Remove crew from the bottom of the steel cage.

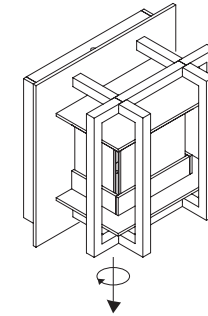

3. Pull the steel frame of lamp holder

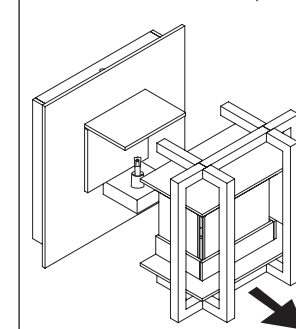

4. Change glass bulb.

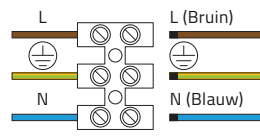
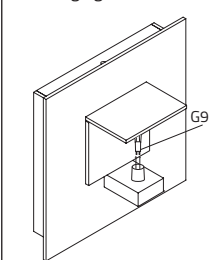

5. Put the steel frame back on like so (Important note: the screw hole must be at the bottom side).

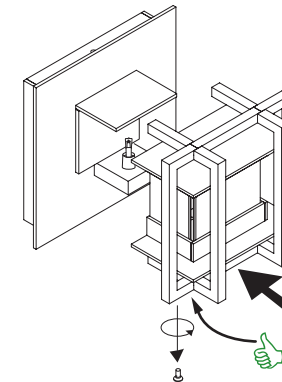

The screw hole at the bottom side.

Do not turn the steel frame upside down (the screw hole must be at the bottom side).

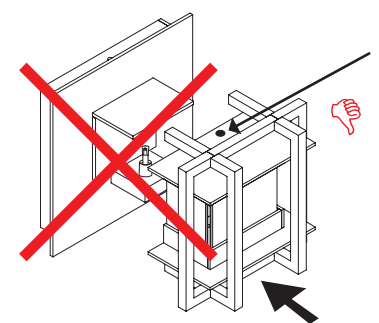

LET OP: Volg en bewaar deze gebruiksaanwijzing.
- Zorg ervoor dat de netspanning uitgeschakeld is voor installatie, reparatie of onderhoud. (Installatie, reparatie en onderhoud uitsluitend door gekwalificeerde personen).
- Voor reparatie of onderhoud uitsluitend originele delen gebruiken. Probeer het product niet zelf te demonteren en te repareren, onjuiste reparaties kunnen het product beschadigen en elektrische schokken veroorzaken wat tot ernstig letsel kan leiden.
- Om waterdichtheid te verzekeren dient u alle onderdelen handvast aan te draaien.
- Dit armatuur niet openen of installeren tijdens regen of hoge luchtvochtigheid.
- Uitsluitend op het etiket aangegeven lichtbronnen gebruiken.

De fabrikant aanvaardt geen aansprakelijkheid voor letsel of schade als gevolg van een verkeerde toepassing van het armatuur.
De fabrikant aanvaardt geen garantie in geval van het niet behandelen van de lampen volgens de richtlijnen van de fabrikant.
Als er schade aan elektrische onderdelen te vinden zijn, vraag dan een elektricien om het te vervangen.

Onderhoud is behoud:

Een goede instandhouding van het armatuur is sterk afhankelijk van omgevings- en onderhoudsfactoren. Hierop kunnen wij geen invloed uitoefenen. Alle producten hebben onderhoud nodig, zo ook uw buitenlamp.
- Schakel voor de zekerheid de elektriciteit uit!
- Wij adviseren om 2x per jaar de armaturen te reinigen.
- Gebruik geen agressieve, schurende of chemische schoonmaakmiddelen.
- Aan de directe kuststreek en de Waddeneilanden adviseren we minimaal 1x per kwartaal de buitenlampen te reinigen.
- Goed onderhoud verlengt het plezier en levensduur van uw buitenlampen.

NOTE: Follow and keep this instructions manual.
- Make sure that the mains voltage is switched off before installation, repair or maintenance. (Installation, repair and maintenance only by qualified persons).
- Use only original parts for repairs or maintenance. Never attempt to disassemble, repair or alter the product in any way, improper repairs could damage the product causing electrical shocks which may cause serious injury.
- Make sure all parts are turned hand tight to be sure the item is waterproof.
- Do not open or install this luminaire during rain or highly humid condition.
- Use only suitable light sources indicated on the label.

The manufacturer accepts no liability for any injuries or damages resulting from the incorrect use or installation of the fixture.
Any operation performed on the fixture that is not in accordance with instructions will void manufacturer's warranty.
If you find any damage to the electrical parts, please ask a qualified electrician to replace it.

Maintenance is preservation:

A good preservation of the fixture is highly dependent on environmental factors and maintenance. We cannot exercise any influence on this. All products require maintenance, including your outdoor fixture.
- Make sure that the mains voltage is switched off before you begin.
- We recommend to clean the fixtures 2x per year.
- Do not use aggressive, abrasive or chemical cleaners.
- On the immediate coast and the Wadden Islands we recommend cleaning the outdoor fixtures at least 1x per quarter.
- Proper maintenance extends the pleasure and lifespan of your outdoor fixtures.

"No rights can be derived from the information provided on this instruction provided on this instruction Manual. Information on the Instruction Manual has been compiled with the utmost care and is updated on a continuous basis. Nevertheless Maretti cannot guarantee that all information is free of errors, complete or fully up to date."