



MARETTI

L I G H T I N G



Maretti Lighting
Bolderweg 7

1332 AX Almere
the Netherlands

T +31 (0) 36 532 66 12

E info@maretti.com
W www.maretti.com

Maretti Lighting is well-known in the World of interior design. In businesses, homes, store chains, and hospitality facilities all over the world, Maretti is unmistakable present with its project lighting that does more than just provide light. We make lighting an essential part of the interior. Maretti stands for stylish top quality and trendsetting design, modern, timeless and most of all, original.

Maretti Lighting works with all the top brands in the lighting industry, but we are especially notable for our own large product line and introduce our own brand name "Maretti". Our production team distinguishes itself time and time again with unique innovations from our own atelier and therefore our projects exude an entirely unique identity.

© Copyright Maretti Projectverlichting.

Our IM was made with the greatest of care. Nevertheless, the colours displayed in the IM may differ slightly from the real colours because of the printing process. Colour, size and range are subject to change. Nothing from this IM may be copied, reproduced and/or published by print, photocopy or in any other way without Maretti Lighting's written permission. All product and design copyrights belong to Maretti Lighting.

GUARANTEE TERMS AND CONDITIONS

The other party should inspect the delivered items immediately upon receipt with regard to its soundness. Entitlements to repair or replacement only exist if the other party

- In the case of visible defects, informs MPV of them immediately.

- In the case of defects that are not visible, informs MPV in writing of the defects, within 2 working days after the day the defects were found, or in all reason could have been found and furthermore demonstrates that the MPV instructions for use, maintenance and operation were followed, whilst the defects are not the consequence of normal wear and tear, misuse, negligence, accident, exceeding the limits prescribed by the MPV or by the legal safety regulations, or, in the case of a repair or change without MPV's consent or the consent of its recognised repairer, there will be no entitlement to repairs or replacement. The parts that have to be replaced must be made available free of charge to MPV. Noncompliance by the other party to one or more of its obligations will release MPV of all its guarantee obligations. In the case of assembly of the other party's own products by Maretti, MPV will release itself from all guarantee stipulations.

Moreover, our general delivery terms and conditions are applicable. These can be obtained from Maretti or can be downloaded from www.maretti.com

The installation must be done by a competent installer. Maretti recommends that your (outside) lighting and fixtures are inspected and maintained annually.

D: Für Garantiebedingungen bitte lesen Sie unsere Webseite www.maretti.com
E: Consulte nuestro sitio web para los condiciones de garantía www.maretti.com
FR: Consultez notre site web pour les conditions de garantie www.maretti.com
NL: Voor garantievoorwaarden zie onze website www.maretti.com

13.3002.COLOUR
13.3004.COLOUR
13.3008.COLOUR

CANDLE PLATEAU SERIES CANDLES



Photo: 13.3004.04

BLACK

04

GENERAL INFORMATION					INFORMATION PERXTURE		
230V	VOLTAGE	DIMMABLE TRIAC	<0,4	SVM	ART.NR.	WAT-TAGE	CANDLES
0W	STANDBY POWER	2700K	KELVIN	<1	PstLM	13.3002.04	9,5W 8x
	DRIVER INCLUDED		INDOOR		CE MARK	13.3004.04	13,5W 12x
	LED INCLUDED	IP20	IP RATING			13.3008.04	23,5W 22x

13.3002.COLOUR
13.3004.COLOUR
13.3008.COLOUR

KAARS PLATEAU SERIES CANDLES

INFO.

SCHAKEL ALTIJD EERST DE STROOM UIT VOORDAT U INSTALLATIE-, ONDERHOUD OF REPARATIEWERKZAAMHEDEN UITVOERT. / ALWAYS SWITCH OF THE MAINS VOLTAGE BEFORE CARRYING OUT INSTALLATION, MAINTENANCE AND REPAIR WORK.

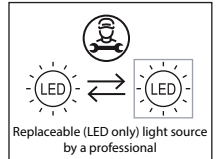
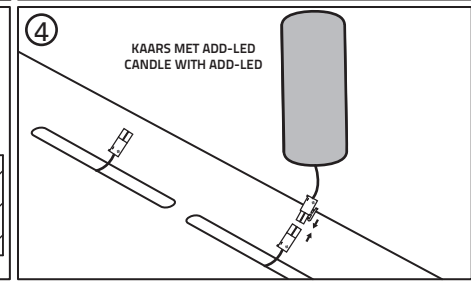
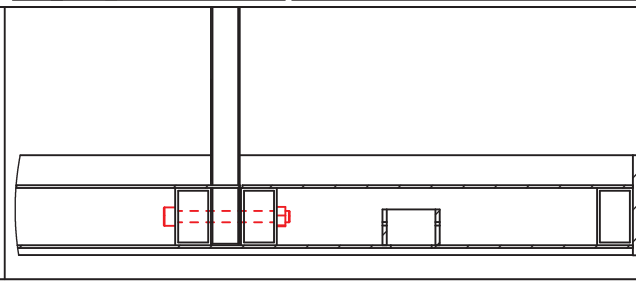
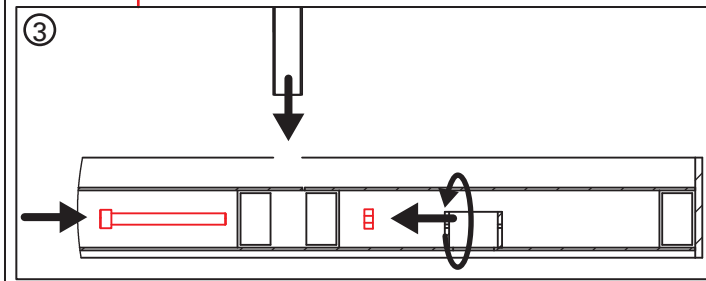
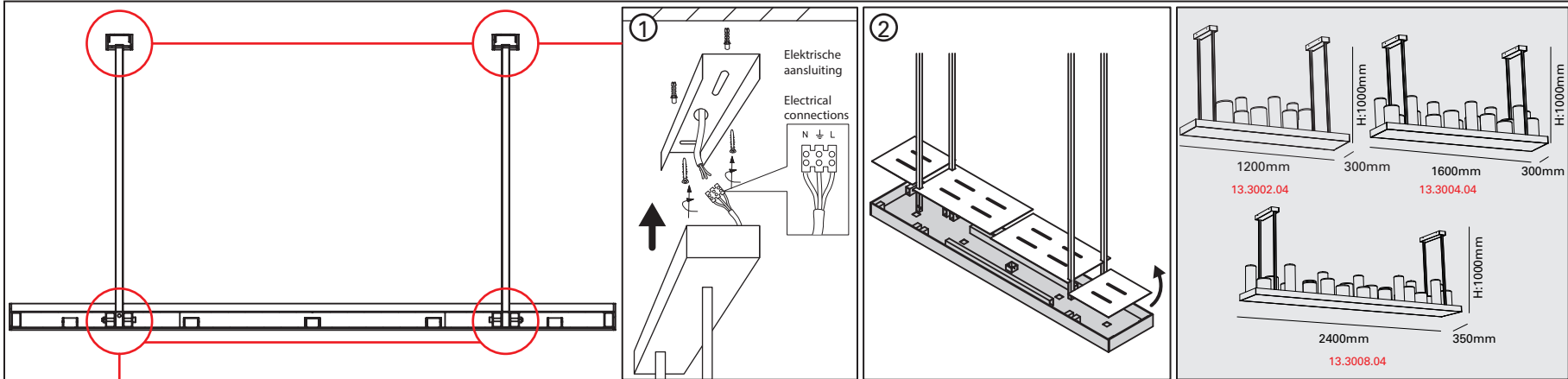

(A) SCHAKEL ALTIJD EERST DE STROOM UIT VOORDAT U INSTALLATIE-, ONDERHOUD OF REPARATIEWERKZAAMHEDEN UITVOERT. ALWAYS SWITCH OF THE MAINS VOLTAGE BEFORE CARRYING OUT INSTALLATION, MAINTENANCE AND REPAIR WORK.

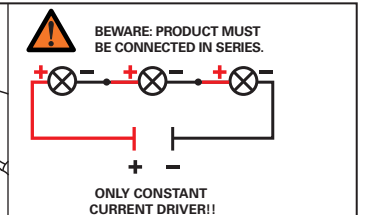
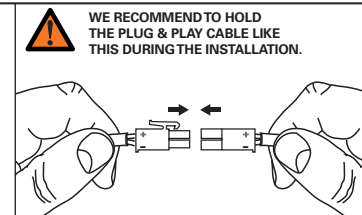
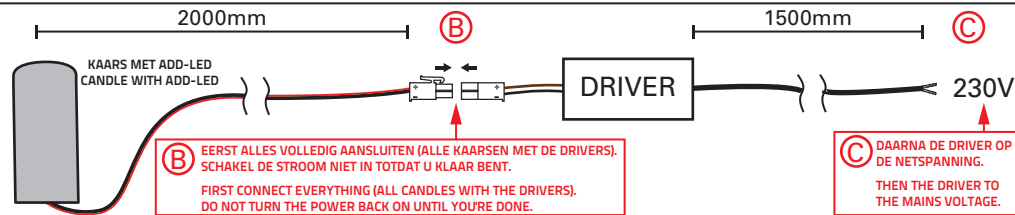

LET OP: Volg en bewaar deze gebruiksaanwijzing.
- Zorg ervoor dat de netspanning uitgeschakeld is voor installatie, reparatie of onderhoud. (Installatie, reparatie en onderhoud uitsluitend door gekwalificeerde personen).
- Voor reparatie of onderhoud uitsluitend originele delen gebruiken. Probeer het product niet zelf te demonteren en te repareren, onjuiste reparaties kunnen het product beschadigen en elektrische schokken veroorzaken wat tot ernstig letsel kan leiden.
- Gebruik het armatuur alleen binnenshuis.
- Het armatuur niet in vochtige of natte ruimte gebruiken.
- Uitsluitend op het etiket aangegeven lichtbronnen gebruiken.

De fabrikant aanvaardt geen enkele aansprakelijkheid voor letsel of schade als gevolg van een verkeerde toepassing van het armatuur.
De fabrikant aanvaardt geen garantie in geval van het niet behandelen van de lampen volgens de richtlijnen van de fabrikant.
Als er schade aan elektrische onderdelen te vinden zijn, vraag dan een elektricien om het te vervangen.

Onderhoud is behoud:
Een goede instandhouding van het armatuur is sterk afhankelijk van omgevings- en onderhoudsfactoren. Hierop kunnen wij geen invloed uitoefenen.
- Schakel voor de zekerheid de elektriciteit uit!
- Gebruik geen agressieve, schurende of chemische schoonmaakmiddelen.

NOTE: Follow and keep this instructions manual.
- Make sure that the mains voltage is switched off before installation, reparation or maintenance. (Installation, reparation and maintenance only by qualified persons).
- Use only original parts for repairs or maintenance. Never attempt to disassemble, repair or alter the product in any way, improper repairs could damage the product causing electrical shocks which may cause serious injury.
- Use the fixture only indoors.
- Don't use the fixture in humid or wet areas.
- Use only suitable light sources indicated on the label.

The manufacturer accepts no liability for any injuries or damages resulting from the incorrect use or installation of the fixture.
Any operation performed on the fixture that is not in accordance with instructions will void manufacturer's warranty.
If you find any damage to the electrical parts, please ask a qualified electrician to replace it.

Maintenance is preservation:
A good preservation of the fixture is highly dependent on environmental factors and maintenance. We cannot exercise any influence on this.
- Make sure that the mains voltage is switched off before you begin.
- Do not use aggressive, abrasive or chemical cleaners.

"No rights can be derived from the information provided on this Instruction Manual. Information on the Instruction Manual has been compiled with the utmost care and is updated on a continuous basis. Nevertheless Maretti cannot guarantee that all information is free of errors, complete or fully up to date."