



Maretti Lighting
Bolderweg 7

1332 AX Almere
the Netherlands

T +31 (0) 36 532 66 12

E info@maretti.com
W www.maretti.com

Maretti Lighting is well-known in the World of interior design. In businesses, homes, store chains, and hospitality facilities all over the world, Maretti is unmistakable present with its project lighting that does more than just provide light. We make lighting an essential part of the interior. Maretti stands for stylish top quality and trendsetting design, modern, timeless and most of all, original.

Maretti Lighting works with all the top brands in the lighting industry, but we are especially notable for our own large product line and introduce our own brand name "Maretti". Our production team distinguishes itself time and time again with unique innovations from our own atelier and therefore our projects exude an entirely unique identity.

© Copyright Maretti Projectverlichting.

Our IM was made with the greatest of care. Nevertheless, the colours displayed in the IM may differ slightly from the real colours because of the printing process. Colour, size and range are subject to change. Nothing from this IM may be copied, reproduced and/or published by print, photocopy or in any other way without Maretti Lighting's written permission. All product and design copyrights belong to Maretti Lighting.

GUARANTEE TERMS AND CONDITIONS

The other party should inspect the delivered items immediately upon receipt with regard to its soundness. Entitlements to repair or replacement only exist if the other party

- In the case of visible defects, informs MPV of them immediately.

- In the case of defects that are not visible, informs MPV in writing of the defects, within 2 working days after the day the defects were found, or in all reason could have been found and furthermore demonstrates that the MPV instructions for use, maintenance and operation were followed, whilst the defects are not the consequence of normal wear and tear, misuse, negligence, accident, exceeding the limits prescribed by the MPV or by the legal safety regulations, or, in the case of a repair or change without MPV's consent or the consent of its recognised repairer, there will be no entitlement to repairs or replacement. The parts that have to be replaced must be made available free of charge to MPV. Noncompliance by the other party to one or more of its obligations will release MPV of all its guarantee obligations. In the case of assembly of the other party's own products by Maretti, MPV will release itself from all guarantee stipulations.

Moreover, our general delivery terms and conditions are applicable. These can be obtained from Maretti or can be downloaded from www.maretti.com

The installation must be done by a competent installer. Maretti recommends that your (outside) lighting and fixtures are inspected and maintained annually.

D: Für Garantiebedingungen bitte lesen Sie unsere Webseite www.maretti.com
E: Consulte nuestro sitio web para los condiciones de garantía www.maretti.com
FR: Consultez notre site web pour les conditions de garantie www.maretti.com
NL: Voor garantievoorwaarden zie onze website www.maretti.com

12.5501.04 LENGTH: 1000mm
12.5502.04 LENGTH: 2000mm
12.5503.04 LENGTH: 3000mm

FORZATRACK SYSTEM DALI

INSTRUCTIONS 1/8

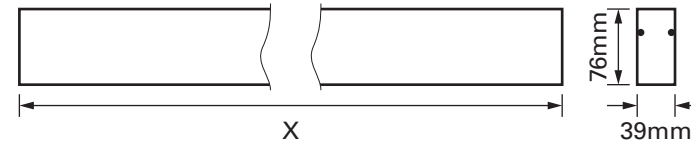
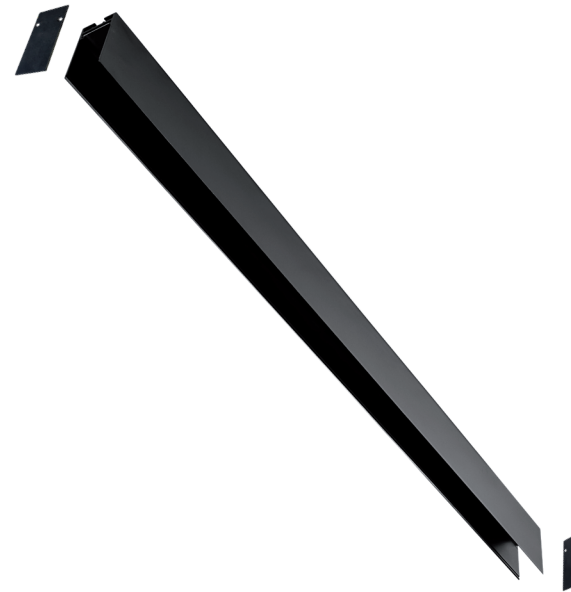

Art. nr.:	12.5501.04	12.5502.04	12.5503.04
Length (X):	1000mm	2000mm	3000mm

BLACK

04

24 VDC	INPUT VOLTAGE		INDOOR		F MARK		ROHS
200W	MAX. WATTAGE		MAGNETIC	END CAP	INCLUDED 2X		CE MARK
IP20	IP RATING	DALI	DIMMING TYPE		CLASS III		

12.5501.04 LENGTH: 1000mm
12.5502.04 LENGTH: 2000mm
12.5503.04 LENGTH: 3000mm

FORZATRACK SYSTEM DALI

INSTRUCTIONS 2/8

FORZATRACK DALI FIXTURES (ORDERED SEPARATELY)

FORZATRACK DALI SYSTEM (ORDERED SEPARATELY)

12.5501.04	(A) FORZATRACK 1000mm	max. 200W
12.5502.04	(B) FORZATRACK 2000mm	max. 200W
12.5503.04	(C) FORZATRACK 3000mm	max. 200W

FORZATRACK DALI FIXTURES (ORDERED SEPARATELY)

12.5510.04	(1) SOLE 35*	6W 300mA DC24V 590 lm 2700 K
12.5511.04	(2) SOLE 35 DOUBLE*	2x6W 600mA DC24V 1180 lm 2700 K
12.5512.colour	(3) SOLE 50*	10W 250mA DC24V 789 lm 2700 K
12.5534.04	(4) STELLA 6*	6x1W 230mA DC24V 420 lm 2700 K
12.5536.04	(5) STELLA 12*	12x1W 450mA DC24V 800 lm 2700 K
12.5540.04	(6) PIEGA 6*	6x1W 230mA DC24V 730 lm 2700 K
12.5552.04	(7) FASCIO 9*	30W 1250mA DC24V 1250 lm 2700 K

FORZATRACK DALI ACCESSORIES (ORDERED SEPARATELY)

12.5571.04	(8) END CAP
12.5570.04	(9) HORIZONTAL CORNER
12.5572.04	(10) INSIDE CORNER
12.5586.04	(11) CONNECTING SLICE INCL. CONNECTING ELEMENT 2X2POLES
12.5476.04	(12) MOUNTING KIT (2 PIECES)
12.5577.04	(13) PENDANT SET (2 PIECES)
12.5480.04	(14) 1000mm PLASTIC TRACK COVER
12.5585.04	(15) POWERBOARD 65MM INCL HEADERS

* DIMMABLE (compatible with DALI, fixtures can be dimmed individually)

DRIVERS ZIJN APART VERKRIJGBAAR / SEPARATE ORDER

ART. NR.	OMSCHRIJVING
519.0400.39	DRIVER 24VDC 100W LINEAR NOT DIMMABLE
519.0400.37	DRIVER 24VDC 200W LINEAR NOT DIMMABLE

<p>(1) 12.5510.04 Sole 35</p>  <p>137x35x55mm (spot: Ø35x80mm)</p>	<p>(2) 12.5511.04 Sole 35 double</p>  <p>137x35x55mm (spot: Ø35x80mm)</p>	<p>(A) 12.5501.04 FORZATRACK system (incl. end cap), Length: 1000mm (B) 12.5502.04 FORZATRACK system (incl. end cap), Length: 2000mm (C) 12.5503.04 FORZATRACK system (incl. end cap), Length: 3000mm</p>  <p>W: 39x H:76mm</p>	
<p>(3) 12.5512.03 Sole 50 12.5512.04 Sole 50</p>  <p>Bronze Black 137,5x34x55mm (spot: Ø50x140mm)</p>	<p>(4) 12.5534.04 Stella 6</p>  <p>164x34x56mm</p>	<p>(5) 12.5536.04 Stella 12</p>  <p>323x34x56mm</p>	
<p>(6) 12.5540.04 Piega 6</p>  <p>164x34x181mm</p>	<p>(7) 12.5552.04 Fascio 9</p>  <p>959x34x56mm</p>		
<p>(8) 12.5571.04 End cap</p> 	<p>(9) 12.5570.04 Horizontal corner Incl. 2x Connecting slice Incl. 2x Connecting element</p> 	<p>(10) 12.5572.04 Inside corner Incl. 2x Connecting slice Incl. 2x Connecting element</p> 	<p>(11) 12.5586.04 Connecting slice Incl. 1x Connecting element 2x2poles</p> 
<p>(12) 12.5476.04 Mounting kit (2x) Screw: M5x90mm</p> 	<p>(13) 12.5577.04 Pendant set (2x) Round plate: Ø80 x H30mm</p> 	<p>(14) 12.5480.04 1000mm Plastic track cover</p> 	<p>(15) 12.5585.04 Powerboard 65mm incl 4x2 headers</p> 

"No rights can be derived from the information provided on this Instruction Manual. Information on the Instruction Manual has been compiled with the utmost care and is updated on a continuous basis. Nevertheless Maretti cannot guarantee that all information is free of errors, complete or fully up to date."

12.5501.04 LENGTH: 1000mm
 12.5502.04 LENGTH: 2000mm
 12.5503.04 LENGTH: 3000mm

FORZATRACK SYSTEM DALI

INSTRUCTIONS 3/8

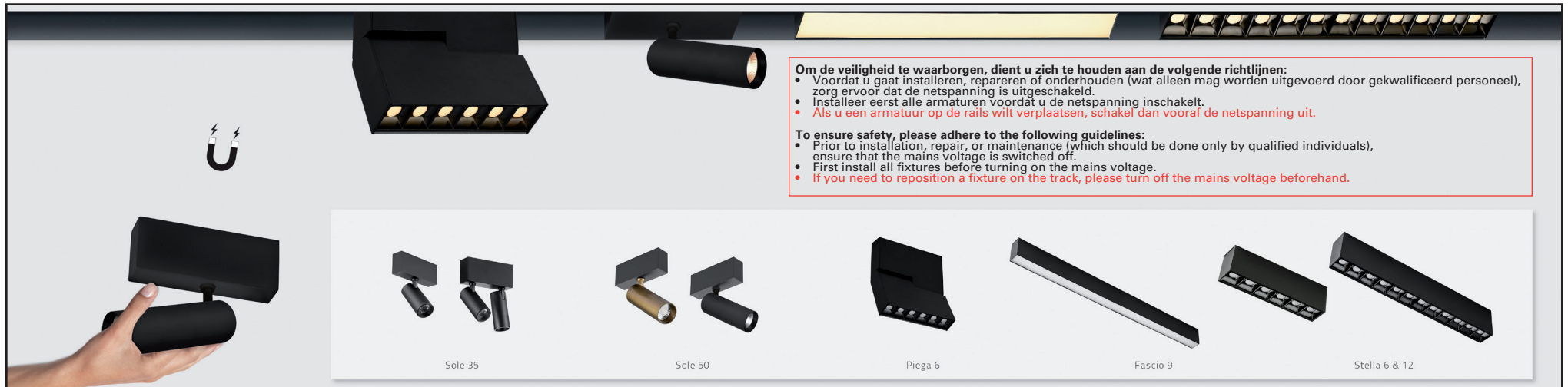
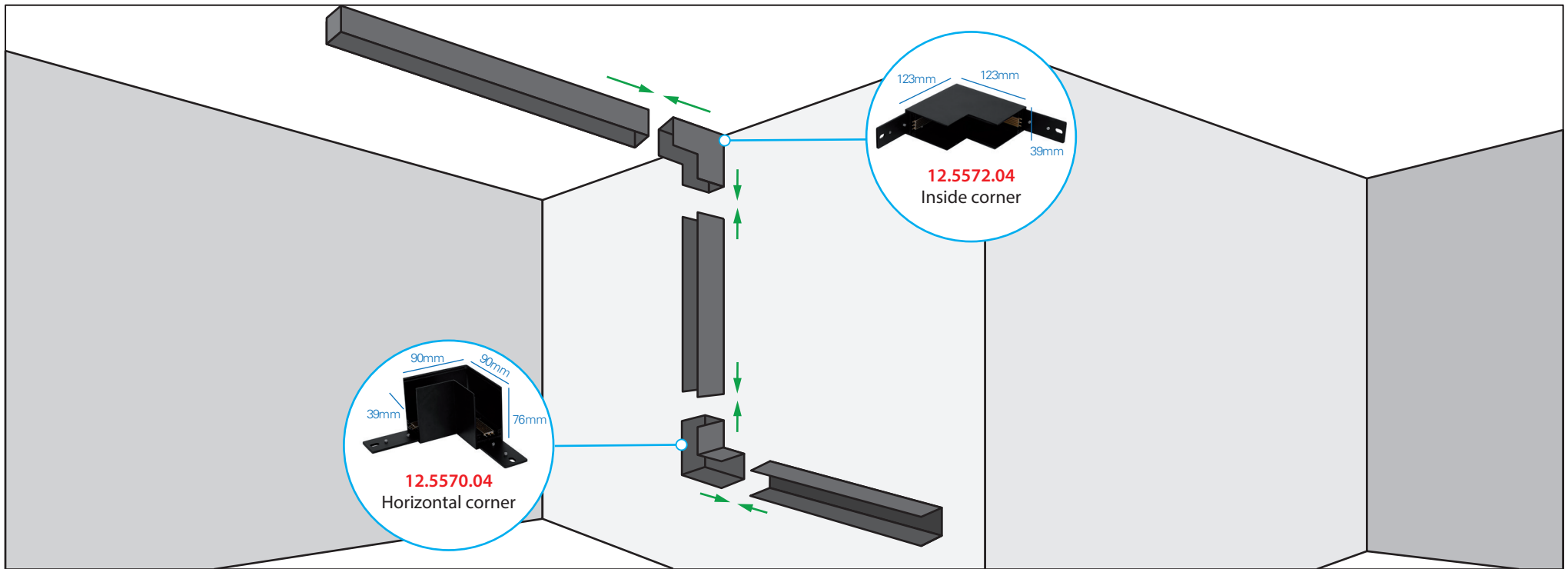

"No rights can be derived from the information provided on this Instruction Manual. Information on the Instruction Manual has been compiled with the utmost care and is updated on a continuous basis. Nevertheless Maretti cannot guarantee that all information is free of errors, complete or fully up to date."

12.5501.04 LENGTH: 1000mm
 12.5502.04 LENGTH: 2000mm
 12.5503.04 LENGTH: 3000mm

FORZATRACK SYSTEM DALI

INSTRUCTIONS 4/8

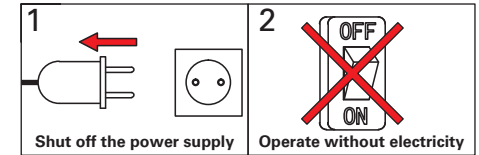

Achterkant armatuur.: Verbinden van de FORZATRACK na inkorten.

Verbinden van de FORZATRACK na inkorten.

Back side fixture. Connecting the FORZATRACK after sawing.

Connecting the FORZATRACK after sawing.

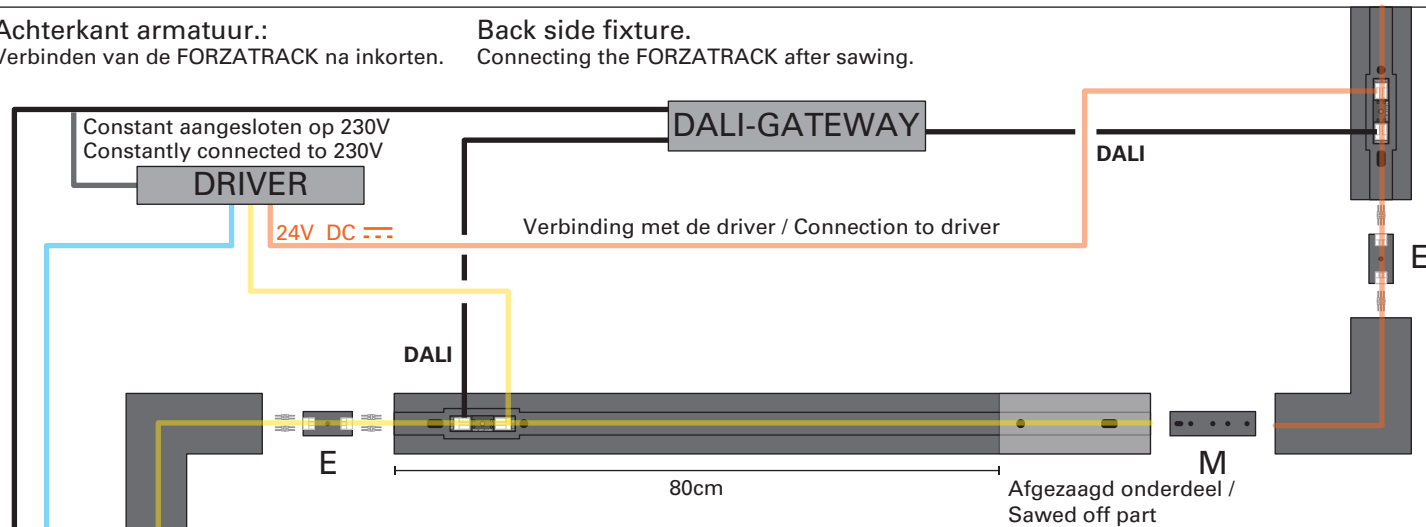

FORZATRACK is beschikbaar in/ is available in:

12.5501.04 1M
 12.5502.04 2M
 12.5503.04 3M

E: Electrical connection

M: Mechanical connection

Type bedrading/Type of wiring

Adereindhuls / Electric wire ferrule



VD-draden / VD-wires



Vertinnen van draden /
Tinning of wires

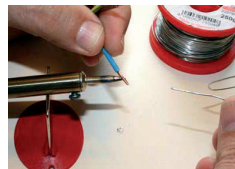

Achterkant / Back side

Het is mogelijk om de FORZATRACK in te korten.
 Voorbeeld:
 Voor een wand van 3,5 meter wordt een track van 3 meter en een track van 1 meter gebruikt.
 De track van 1 meter dient ingekort te worden tot een lengte van 50cm.
 Let op: de zijde met aansluitstekkers niet afzagen!

You can adjust the size of the FORZATRACK.
 Example:
 For a wall of 3.5 metres, a track of 3 metres and a track of 1 metre is used.
 The track of 1 metre can be adjusted to 50cms.

Note: do not saw off the side with connection plugs!

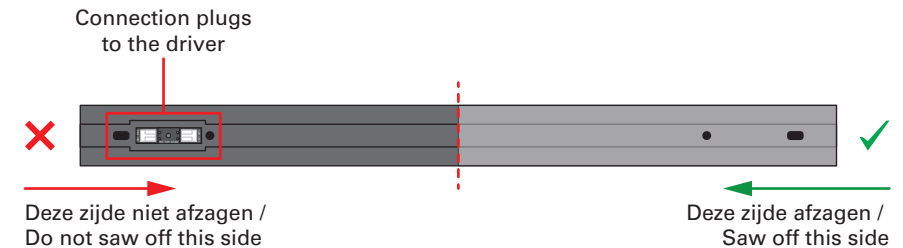

Afgezaagd onderdeel /
Sawed off part

Close-up

MAX.
2,5mm²

Voorkant / Front side

Dummy part
 Geen elektrisch circuit
 No electrical circuit

Electrical circuit

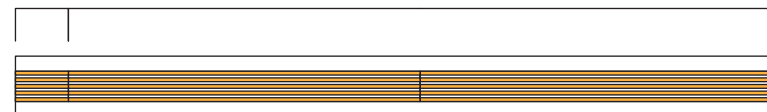

"No rights can be derived from the information provided on this Instruction Manual. Information on the Instruction Manual has been compiled with the utmost care and is updated on a continuous basis. Nevertheless Maretti cannot guarantee that all information is free of errors, complete or fully up to date."

12.5501.04 LENGTH: 1000mm
 12.5502.04 LENGTH: 2000mm
 12.5503.04 LENGTH: 3000mm

FORZATRACK SYSTEM DALI

INSTRUCTIONS 5/8

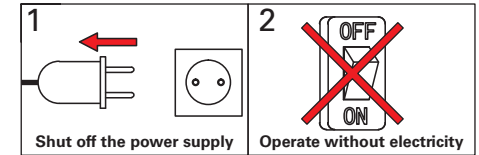

Mounting instruction: surface mounted (If you want to cut the FORZATRACK please read the below information)

<p>1</p> <p>BELANGRIJK! Na het zagen, is het belangrijk om de printbaan af te bramen om te voorkomen dat er een elektrische sluiting ontstaat op het staal.</p> <p>IMPORTANT! After sawing, it is important to deburr the PCB to prevent an electrical closure on the steel.</p>	<p>Het is mogelijk om de FORZATRACK in te korten. Voorbeeld: Voor een wand van 3,5 meter wordt een track van 3 meter en een track van 1 meter gebruikt. De track van 1 meter dient ingekort te worden tot een lengte van 50cm. Let op: de zijde met aansluitstekkers niet afzagen!</p> <p>You can adjust the size of the FORZATRACK. Example: For a wall of 3.5 metres, a track of 3 metres and a track of 1 metre is used. The track of 1 metre can be adjusted to 50cms. Note: do not saw off the side with connection plugs!</p> <p>Connection plugs to the driver</p> <p>Do not saw off this side</p> <p>Saw off this side</p>	<p>2</p> <p>Achterkant / Back side</p> <p>Hier zagen Saw here</p> <p>1M</p> <p>0,5M</p>	
<p>3</p> <p>Back side</p>	<p>4</p> <p>Zorg ervoor dat u het elektrische circuit verplaatst voordat u een gat boort, om beschadiging te voorkomen.</p> <p>Please make sure to move the electrical circuit before drilling a hole, to prevent damage.</p> <p>a- Verwijder het dummydeel. b- Verwijder de magneet (om het elektrische circuit te kunnen schuiven). c- Schuif het elektrische circuit naar de andere kant. d- Draai de FORZATRACK om, boor een gat.</p> <p>a- Remove the dummy part. b- Remove the magnet (to be able to slide the electrical circuit). c- Slide the electrical circuit to the other side. d- Turn over the FORZATRACK, drill a hole.</p> <p>Dummy part Geen elektrisch circuit No electrical circuit</p> <p>Verwijder de magneet Remove the magnet</p> <p>Electrical circuit</p> <p>Electrical circuit</p> <p>Electrical circuit</p>		
<p>5</p> <p>Draai de FORZATRACK om Turn over the FORZATRACK</p> <p>Achterkant / Back side</p> <p>d. Drill a hole so you can mount the track later</p> <p>Ø9,5mm</p> <p>Zorg ervoor dat u het elektrische circuit niet aanraakt met de boor Please make sure that you do not touch the electrical circuit with the drill</p>	<p>6</p> <p>Achterkant / Back side</p> <p>Afbramen Verwijder de scherpe rand Deburring Remove sharp raised edges</p>	<p>7</p> <p>Verplaatst het elektrische circuit terug Move the electrical circuit back</p> <p>Electrical circuit</p>	<p>8</p> <p>Plaats de magneet terug en dan zet het dummydeel weer op Put back the magnet and then put the dummy part back on</p>

"No rights can be derived from the information provided on this Instruction Manual. Information on the Instruction Manual has been compiled with the utmost care and is updated on a continuous basis. Nevertheless Maretti cannot guarantee that all information is free of errors, complete or fully up to date."

12.5501.04 LENGTH: 1000mm
12.5502.04 LENGTH: 2000mm
12.5503.04 LENGTH: 3000mm

FORZATRACK SYSTEM DALI

INSTRUCTIONS 6/8



LET OP: Volg en bewaar deze gebruiksaanwijzing.

- Zorg ervoor dat de netspanning uitgeschakeld is voor installatie, reparatie of onderhoud.
 (Installatie, reparatie en onderhoud uitsluitend door gekwalificeerde personen).

- Voor reparatie of onderhoud uitsluitend originele delen gebruiken.

- Probeer het product niet zelf te demonteren en te repareren, onjuiste reparaties kunnen het product beschadigen en elektrische schokken veroorzaken wat tot ernstig letsel kan leiden. Gebruik het armatuur alleen binnenshuis.

- Het armatuur niet in vochtige of natte ruimte gebruiken.

- Uitsluitend op het etiket aangegeven lichtbronnen gebruiken.

De fabrikant aanvaardt geen enkele aansprakelijkheid voor letsel of schade als gevolg van een verkeerde toepassing van het armatuur. De fabrikant aanvaardt geen garantie in geval van het niet behandelen van de lampen volgens de richtlijnen van de fabrikant. Als er schade aan elektrische onderdelen te vinden zijn, vraag dan een elektricien om het te vervangen.

Onderhoud is behoud:

Een goede instandhouding van het armatuur is sterk afhankelijk van omgevings- en onderhoudsfactoren. Hierop kunnen wij geen invloed uitoefenen.

- Schakel voor de zekerheid de elektriciteit uit!

- Gebruik geen agressieve, schurende of chemische schoonmaakmiddelen.

NOTE: Follow and keep this instructions manual.

- Make sure that the mains voltage is switched off before installation, repair or maintenance.

(Installation, repair and maintenance only by qualified persons).

- Use only original parts for repairs or maintenance.

- Never attempt to disassemble, repair or alter the product in any way, improper repairs could damage the product causing electrical shocks which may cause serious injury.

- Use the fixture only indoors.

- Don't use the fixture in humid or wet areas.

- Use only suitable light sources indicated on the label.

The manufacturer accepts no liability for any injuries or damages resulting from the incorrect use or installation of the fixture. Any operation performed on the fixture that is not in accordance with instructions will void manufacturer's warranty. If you find any damage to the electrical parts, please ask a qualified electrician to replace it.

Maintenance is preservation:

A good preservation of the fixture is highly dependent on environmental factors and maintenance. We cannot exercise any influence on this.

- Make sure that the mains voltage is switched off before you begin.

- Do not use aggressive, abrasive or chemical cleaners.

<p>1</p> <p>Schakel de stroomvoorziening Shut off the power supply</p>	<p>2</p> <p>Werk zonder elektriciteit Work without electricity</p>
--	--

I vorm verbinding / I shape connection

A1 Voorzien van verbindingsstuk
Fitted with connecting piece

A2 Met schroeven bevestigen
Lock back screw

A3 Compleet / Complete

Connecting slice
Art.No:12.5586.04

Installeren
Install

Electrical connection:
When connecting the FORZATRACK system electrically, the whole circuit is max 200W
A= 200W (A+B= max.200W)

Mechanical connection:
When connecting the FORZATRACK system mechanically, each individual track part is max 200W

L vorm verbinding / L shape connection

FORZATRACK horizontal corner not incl.
Art.No:12.5570.04

A1 Voorzien van verbindingsstuk
Fitted with connecting piece

A2 Met schroeven bevestigen
Mount with screws

A3 Compleet / Complete

Installeren
Install

"No rights can be derived from the information provided on this Instruction Manual. Information on the Instruction Manual has been compiled with the utmost care and is updated on a continuous basis. Nevertheless Maretti cannot guarantee that all information is free of errors, complete or fully up to date."

12.5501.04 LENGTH: 1000mm
12.5502.04 LENGTH: 2000mm
12.5503.04 LENGTH: 3000mm

FORZATRACK SYSTEM DALI

INSTRUCTIONS 7/8

1	2
Schakel de stroomvoorziening Shut off the power supply	Werk zonder elektriciteit Work without electricity

FORZATRACK Mounting instruction: recessed Let op: Draag voor de installatie handschoenen.
 Note: Wear gloves before installation.



LET OP: Volg en bewaar deze gebruiksaanwijzing.
 -Zorg ervoor dat de netspanning uitgeschakeld is voor installatie, reparatie of onderhoud. (Installatie, reparatie en onderhoud uitsluitend door gekwalificeerde personen).
 -Voor reparatie of onderhoud uitsluitend originele delen gebruiken. Probeer het product niet zelf te demonteren en te repareren, onjuiste reparaties kunnen het product beschadigen en elektrische schokken veroorzaken wat tot ernstig letsel kan leiden. Gebruik het armatuur alleen binnenshuis.
 -Het armatuur niet in vochtige of natte ruimte gebruiken.
 -Uitsluitend op het etiket aangegeven lichtbronnen gebruiken.

De fabrikant aanvaardt geen enkele aansprakelijkheid voor letsel of schade als gevolg van een verkeerde toepassing van het armatuur. De fabrikant aanvaardt geen garantie in geval van het niet behandelen van de lampen volgens de richtlijnen van de fabrikant. Als er schade aan elektrische onderdelen te vinden zijn, vraag dan een elektricien om het te vervangen.

Onderhoud is behoud:

Een goede instandhouding van het armatuur is sterk afhankelijk van omgevings- en onderhoudsfactoren. Hierop kunnen wij geen invloed uitoefenen.
 -Schakel voor de zekerheid de elektriciteit uit!
 -Gebruik geen agressieve, schurende of chemische schoonmaakmiddelen.

NOTE: Follow and keep this instructions manual.

-Make sure that the mains voltage is switched off before installation, reparation or maintenance. (Installation, reparation and maintenance only by qualified persons).
 -Use only original parts for repairs or maintenance.
 Never attempt to disassemble, repair or alter the product in any way, improper repairs could damage the product causing electrical shocks which may cause serious injury.
 -Use the fixture only indoors.
 -Don't use the fixture in humid or wet areas.
 -Use only suitable light sources indicated on the label.

The manufacturer accepts no liability for any injuries or damages resulting from the incorrect use or installation of the fixture. Any operation performed on the fixture that is not in accordance with instructions will void manufacturer's warranty. If you find any damage to the electrical parts, please ask a qualified electrician to replace it.

Maintenance is preservation:

A good preservation of the fixture is highly dependent on environmental factors and maintenance. We cannot exercise any influence on this.
 -Make sure that the mains voltage is switched off before you begin.
 -Do not use aggressive, abrasive or chemical cleaners.

A1 Bevestig de rail met de schroef losjes aan de inbouwbeugel door enkele keren te draaien. Loosely mount the track onto the bracket by twisting the screw a few times.

A2 Draai the beugel 90° om deze in het plafond te plaatsen. Twist the bracket 90° to place it in the ceiling.

A3 Draai de beugel terug middels de schroef, om deze op het plafond te laten rusten. Twist back de bracket by using the screw, and let it rest on the ceiling.

A4

Bevestig de beugel aan het plafond met twee zelf tappende schroeven. Fix the bracket onto the ceiling by using two self-tapping screws.

A5 Hoogte-instelling van de FORZATRACK. Track height adjustment.

Track verhoogd tot hetzelfde niveau met het plafond. Track raised to the same level with the ceiling.

A6 Installeren / Install

Decoratieve onderdelen die op deze locatie zijn geïnstalleerd. Decorative parts installed in this location.

Voorbeeld. Armaturen worden apart besteld / Example. Fixtures are ordered separately.

Om de veiligheid te waarborgen, dient u zich te houden aan de volgende richtlijnen:

- Voordat u gaat installeren, repareren of onderhouden (wat alleen mag worden uitgevoerd door gekwalificeerd personeel), zorg ervoor dat de netspanning is uitgeschakeld.
- Installeer eerst alle armaturen voordat u de netspanning inschakelt.
- **Als u een armatuur op de rails wilt verplaatsen, schakel dan vooraf de netspanning uit.**

To ensure safety, please adhere to the following guidelines:

- Prior to installation, repair, or maintenance (which should be done only by qualified individuals), ensure that the mains voltage is switched off.
- First install all fixtures before turning on the mains voltage.
- **If you need to reposition a fixture on the track, please turn off the mains voltage beforehand.**

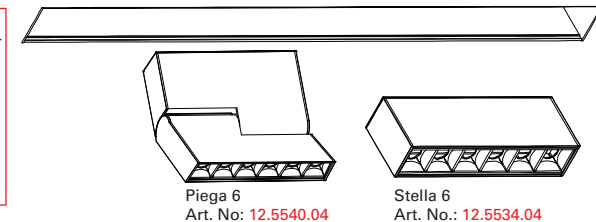

"No rights can be derived from the information provided on this Instruction Manual. Information on the Instruction Manual has been compiled with the utmost care and is updated on a continuous basis. Nevertheless Maretti cannot guarantee that all information is free of errors, complete or fully up to date."

12.5501.04 LENGTH: 1000mm
12.5502.04 LENGTH: 2000mm
12.5503.04 LENGTH: 3000mm

FORZATRACK SYSTEM DALI

INSTRUCTIONS 8/8

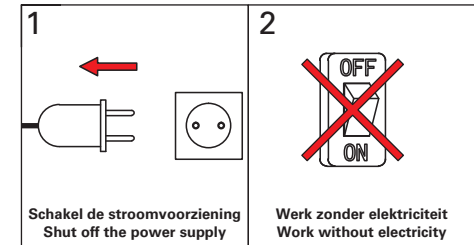

FORZATRACK (Ophanging/suspension) Let op: Draag voor de installatie handschoenen. Note: Wear gloves before installation.

LET OP: Volg en bewaar deze gebruiksaanwijzing.
 -Zorg ervoor dat de netspanning uitgeschakeld is voor installatie, reparatie of onderhoud. (Installatie, reparatie en onderhoud uitsluitend door gekwalificeerde personen).
 -Voor reparatie of onderhoud uitsluitend originele delen gebruiken. Probeer het product niet zelf te demonteren en te repareren, onjuiste reparaties kunnen het product beschadigen en elektrische schokken veroorzaken wat tot ernstig letsel kan leiden. Gebruik het armatuur alleen binnenshuis.
 -Het armatuur niet in vochtige of natte ruimte gebruiken.
 -Uitsluitend op het etiket aangegeven lichtbronnen gebruiken.

De fabrikant aanvaardt geen enkele aansprakelijkheid voor letsel of schade als gevolg van een verkeerde toepassing van het armatuur. De fabrikant aanvaardt geen garantie in geval van het niet behandelen van de lampen volgens de richtlijnen van de fabrikant. Als er schade aan elektrische onderdelen te vinden zijn, vraag dan een elektricien om het te vervangen.

Onderhoud is behoud:

Een goede instandhouding van het armatuur is sterk afhankelijk van omgevings- en onderhoudsfactoren. Hierop kunnen wij geen invloed uitoefenen.
 -Schakel voor de zekerheid de elektriciteit uit!
 -Gebruik geen agressieve, schurende of chemische schoonmaakmiddelen.

NOTE: Follow and keep this instructions manual.

-Make sure that the mains voltage is switched off before installation, reparation or maintenance. (Installation, reparation and maintenance only by qualified persons).
 -Use only original parts for repairs or maintenance. Never attempt to disassemble, repair or alter the product in any way, improper repairs could damage the product causing electrical shocks which may cause serious injury.
 -Use the fixture only indoors.
 -Don't use the fixture in humid or wet areas.
 -Use only suitable light sources indicated on the label.

The manufacturer accepts no liability for any injuries or damages resulting from the incorrect use or installation of the fixture. Any operation performed on the fixture that is not in accordance with instructions will void manufacturer's warranty. If you find any damage to the electrical parts, please ask a qualified electrician to replace it.

Maintenance is preservation:

A good preservation of the fixture is highly dependent on environmental factors and maintenance. We cannot exercise any influence on this.
 -Make sure that the mains voltage is switched off before you begin.
 -Do not use aggressive, abrasive or chemical cleaners.

A1 Bovenaanzicht / Top view

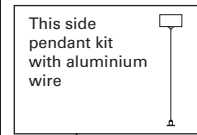

Pendant set not incl.
Art. No: 12.5577.04

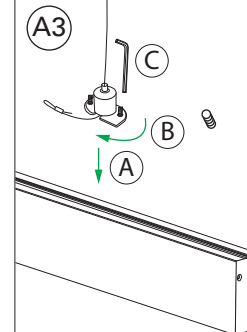
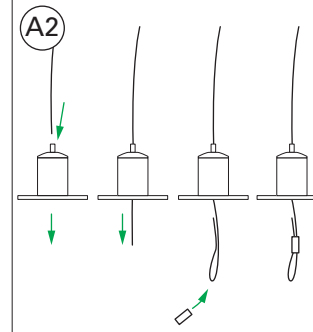
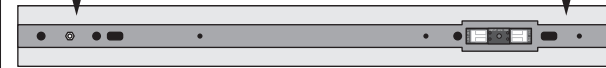
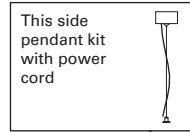

Bovenaanzicht / Top view Close-up

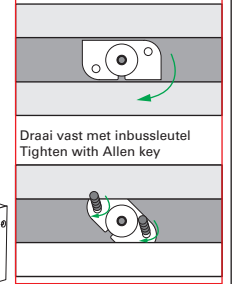

A4 Bovenaanzicht / Top view Close-up

Trekontlaster incl. bij de FORZATRACK
Strain relief incl. with the FORZATRACK

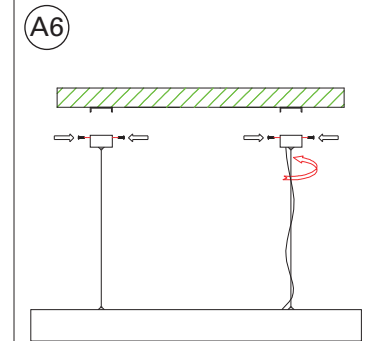
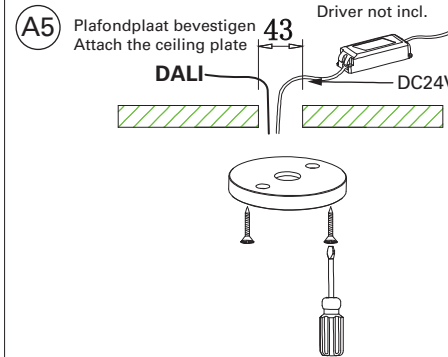
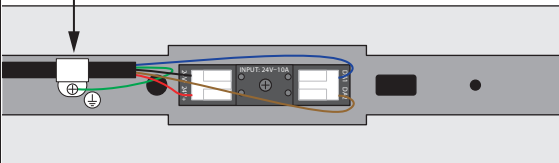
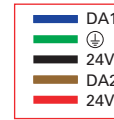

A7 Pas de lengte van de draad aan om de installatie te voltooien.
Adjust the length of wire to complete the installation.

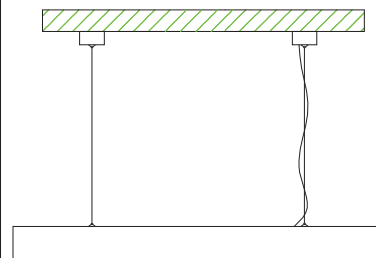

Voorbeeld. Armaturen worden apart besteld / Example. Fixtures are ordered separately.

Om de veiligheid te waarborgen, dient u zich te houden aan de volgende richtlijnen:

- Voordat u gaat installeren, repareren of onderhouden (wat alleen mag worden uitgevoerd door gekwalificeerd personeel), zorg ervoor dat de netspanning is uitgeschakeld.
- Installeer eerst alle armaturen voordat u de netspanning inschakelt.
- Als u een armatuur op de rails wilt verplaatsen, schakel dan vooraf de netspanning uit.

To ensure safety, please adhere to the following guidelines:

- Prior to installation, repair, or maintenance (which should be done only by qualified individuals), ensure that the mains voltage is switched off.
- First install all fixtures before turning on the mains voltage.
- If you need to reposition a fixture on the track, please turn off the mains voltage beforehand.

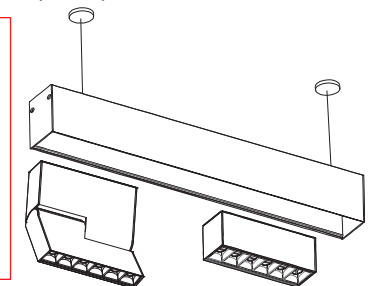

Piega 6 Art. No: 12.5540.04
 Stella 6 Art. No: 12.5534.04

"No rights can be derived from the information provided on this Instruction Manual. Information on the Instruction Manual has been compiled with the utmost care and is updated on a continuous basis. Nevertheless Maretti cannot guarantee that all information is free of errors, complete or fully up to date."