



MARETTI LIGHTING



Maretti Lighting
Bolderweg 7

1332 AX Almere
the Netherlands

T +31 (0) 36 532 66 12
F +31 (0) 36 532 17 35

E info@maretti.com
W www.maretti.com

Maretti Lighting is well-known in the World of interior design. In businesses, homes, store chains, and hospitality facilities all over the world, Maretti is unmistakable present with its project lighting that does more than just provide light. We make lighting an essential part of the interior. Maretti stands for stylish top quality and trendsetting design, modern, timeless and most of all, original.

Maretti Lighting works with all the top brands in the lighting industry, but we are especially notable for our own large product line and introduce our own brand name "Maretti". Our production team distinguishes itself time and time again with unique innovations from our own atelier and therefore our projects exude an entirely unique identity.

© Copyright Maretti Projectverlichting.

Our IM was made with the greatest of care. Nevertheless, the colours displayed in the IM may differ slightly from the real colours because of the printing process. Colour, size and range are subject to change. Nothing from this IM may be copied, reproduced and/or published by print, photocopy or in any other way without Maretti Lighting's written permission. All product and design copyrights belong to Maretti Lighting.

GUARANTEE TERMS AND CONDITIONS

The other party should inspect the delivered items immediately upon receipt with regard to its soundness. Entitlements to repair or replacement only exist if the other party

- In the case of visible defects, informs MPV of them immediately.

- In the case of defects that are not visible, informs MPV in writing of the defects, within 2 working days after the day the defects were found, or in all reason could have been found and furthermore demonstrates that the MPV instructions for use, maintenance and operation were followed, whilst the defects are not the consequence of normal wear and tear, misuse, negligence, accident, exceeding the limits prescribed by the MPV or by the legal safety regulations, or, in the case of a repair or change without MPV's consent or the consent of its recognised repairer, there will be no entitlement to repairs or replacement. The parts that have to be replaced must be made available free of charge to MPV. Noncompliance by the other party to one or more of its obligations will release MPV of all its guarantee obligations. In the case of assembly of the other party's own products by Maretti, MPV will release itself from all guarantee stipulations. Moreover, our general delivery terms and conditions are applicable. These can be obtained from Maretti or can be downloaded from www.maretti.com

The installation must be done by a competent installer. Maretti recommends that your (outside) lighting and fixtures are inspected and maintained annually.

D: Für Garantiebedingungen bitte lesen Sie unsere Webseite www.maretti.com
E: Consulte nuestro sitio web para los condiciones de garantía www.maretti.com
FR: Consultez notre site web pour les conditions de garantie www.maretti.com
NL: Voor garantievoorwaarden zie onze website www.maretti.com

12.5432.COLOUR.A STELLA 3
12.5434.COLOUR.A STELLA 6
12.5436.COLOUR.A STELLA 12

MAGNETRACK STELLA SERIES

INSTRUCTIONS 1/9



12.5434.04.A
MagneTrack Stella 6



12.5432.04.A
MagneTrack Stella 3

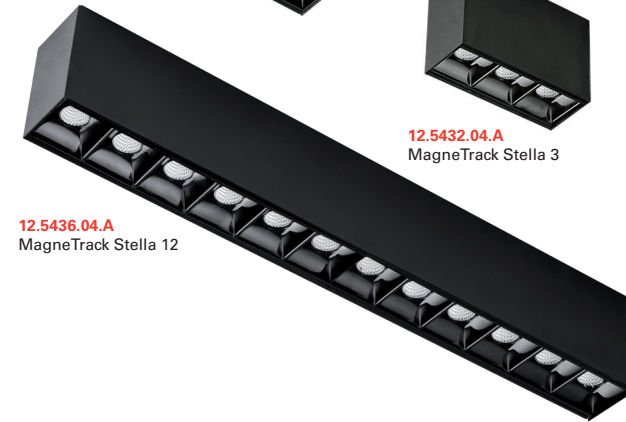

12.5436.04.A
MagneTrack Stella 12

BLACK



DIMMABLE (compatible with 1-10V and DALI but fixtures cannot be dimmed individually)

GENERAL INFORMATION				INFORMATION PER FIXTURE			
DC 24V	VOLTAGE	DIMMABLE FIXTURES CANNOT BE DIM INDIVIDUALLY		ART. NR.	12.5432.04.A	12.5434.04.A	12.5436.04.A
	LED BULB INCLUDED	25.000 h	LIFETIME	NAME FIXTURE	Stella 3	Stella 6	Stella 12
IP20	IP RATING		DEGREE BEAM ANGLE 34°	WATTAGE	3x1W	6x1W	12x1W
	INDOOR		MAGNETIC TRACK SYSTEM	MILLI-AMPÈRE	130mA	230mA	450mA
2700K	KELVIN		CE MARK	LUMEN	200 lm	672 lm	800 lm
>80	CRI						

DIT PRODUCT BEVAT EEN LICHTBRON VAN ENERGIE-EFFICIËNTIEKLASSE: F
THIS PRODUCT CONTAINS A LIGHT SOURCE OF ENERGY EFFICIENCY CLASS: F

12.5432.COLOUR.A STELLA 3
 12.5434.COLOUR.A STELLA 6
 12.5436.COLOUR.A STELLA 12

MAGNETRACK STELLA SERIES

INSTRUCTIONS 2/9

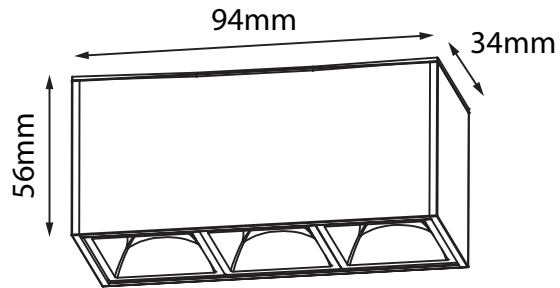

12.5432.04.A
 MagneTrack Stella 3

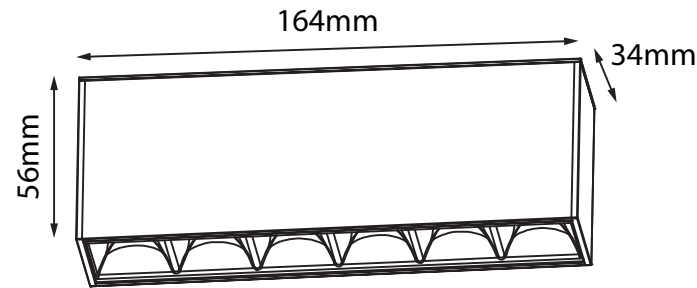

12.5434.04.A
 MagneTrack Stella 6

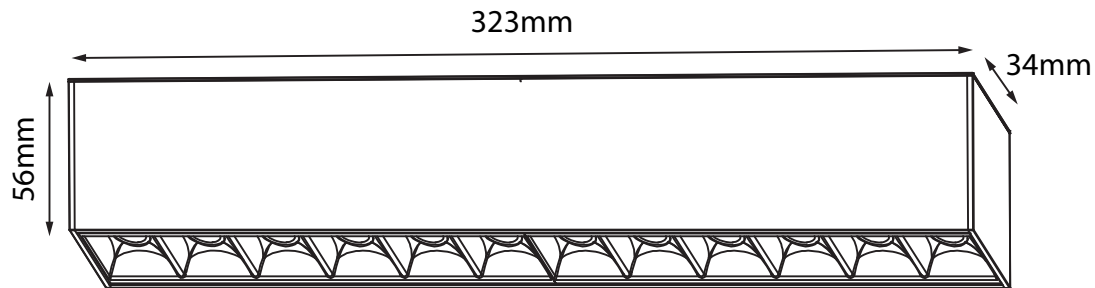

12.5436.04.A
 MagneTrack Stella 12

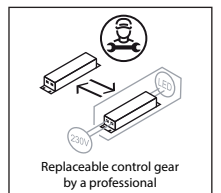
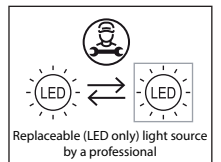

LET OP: Volg en bewaar deze gebruiksaanwijzing.
 - Zorg ervoor dat de netspanning uitgeschakeld is voor installatie, reparatie of onderhoud. (Installatie, reparatie en onderhoud uitsluitend door gekwalificeerde personen).
 - Voor reparatie of onderhoud uitsluitend originele delen gebruiken. Probeer het product niet zelf te demonteren en te repareren, onjuiste reparaties kunnen het product beschadigen en elektrische schokken veroorzaken wat tot ernstig letsel kan leiden.
 - Gebruik het armatuur alleen binnenshuis.
 - Het armatuur niet in vochtige of natte ruimte gebruiken.
 - Uitsluitend op het etiket aangegeven lichtbronnen gebruiken.

De fabrikant aanvaardt geen enkele aansprakelijkheid voor letsel of schade als gevolg van een verkeerde toepassing van het armatuur.
 De fabrikant aanvaardt geen garantie in geval van het niet behandelen van de lampen volgens de richtlijnen van de fabrikant.
 Als er schade aan elektrische onderdelen te vinden zijn, vraag dan een electricien om het te vervangen.

Onderhoud is behoud:
 Een goede instandhouding van het armatuur is sterk afhankelijk van omgevings- en onderhoudsfactoren. Hierop kunnen wij geen invloed uitoefenen.
 - Schakel voor de zekerheid de elektriciteit uit!
 - Gebruik geen agressieve, schurende of chemische schoonmaakmiddelen.

NOTE: Follow and keep this instructions manual.
 - Make sure that the mains voltage is switched off before installation, reparation or maintenance. (Installation, reparation and maintenance only by qualified persons).
 - Use only original parts for repairs or maintenance. Never attempt to disassemble, repair or alter the product in any way, improper repairs could damage the product causing electrical shocks which may cause serious injury.
 - Use the fixture only indoors.
 - Don't use the fixture in humid or wet areas.
 - Use only suitable light sources indicated on the label.

The manufacturer accepts no liability for any injuries or damages resulting from the incorrect use or installation of the fixture.
 Any operation performed on the fixture that is not in accordance with instructions will void manufacturer's warranty.
 If you find any damage to the electrical parts, please ask a qualified electrician to replace it.

Maintenance is preservation:
 A good preservation of the fixture is highly dependent on environmental factors and maintenance. We cannot exercise any influence on this.
 - Make sure that the mains voltage is switched off before you begin.
 - Do not use aggressive, abrasive or chemical cleaners.

"No rights can be derived from the information provided on this Instruction Manual. Information on the Instruction Manual has been compiled with the utmost care and is updated on a continuous basis. Nevertheless Maretti cannot guarantee that all information is free of errors, complete or fully up to date."

12.5432.COLOUR.A STELLA 3
 12.5434.COLOUR.A STELLA 6
 12.5436.COLOUR.A STELLA 12

MAGNETRACK STELLA SERIES

INSTRUCTIONS 3/9

MAGNETRACK FIXTURES (ORDERED SEPARATELY)

MAGNETRACK SYSTEM (ORDERED SEPARATELY)

12.5401.04.A	A	MAGNETRACK 1000mm	max.200W
12.5402.04.A	B	MAGNETRACK 2000mm	max.200W
12.5403.04.A	C	MAGNETRACK 3000mm	max.200W

MAGNETRACK FIXTURES (ORDERED SEPARATELY)

12.5410.04	1	SOLE 35*	5W 250mA DC24V 325 lm 2700 K
12.5411.04	2	SOLE 35 DOUBLE*	2x5W 500mA DC24V 650 lm 2700 K
12.5412.colour.A	3	SOLE 50*	10W 250mA DC24V 687 lm 2700 K
12.5432.04.A	4	STELLA 3*	3x1W 130mA DC24V 200 lm 2700 K
12.5434.04.A	5	STELLA 6*	6x1W 230mA DC24V 672 lm 2700 K
12.5436.04.A	6	STELLA 12*	12x1W 450mA DC24V 800 lm 2700 K
12.5440.04.A	7	PIEGA 3*	3x1W 130mA DC24V 200 lm 2700 K
12.5442.04.A	8	PIEGA 6*	6x1W 230mA DC24V 730 lm 2700 K
12.5450.04.A	9	FASCIO 3*	10W 450mA DC24V 400 lm 2700 K
12.5453.04.A	10	FASCIO 6*	20W 930mA DC24V 900 lm 2700 K
12.5456.04.A	11	FASCIO 9*	30W 1250mA DC24V 1250 lm 2700 K

MAGNETRACK ACCESSORIES (ORDERED SEPARATELY)

12.5470.04.A	12	OUTSIDE CORNER
12.5471.04	13	END CAP
12.5472.04.A	14	HORIZONTAL CORNER
12.5473.04.A	15	INSIDE CORNER
12.5474.04.A	16	CONNECTING SLICE (2 PIECES) INCL. ELECTRICAL JOINER
12.5476.04	17	MOUNTING KIT (2 PIECES)
12.5477.04.B	18	PENDANT SET (2 PIECES)
12.5480.04	19	1000mm PLASTIC TRACK COVER
12.5485.04	20	POWERBOARD 65MM INCL HEADERS
12.5490.00	21	CONNECTING ELEMENT 3-POLES (FOR MAGNETRACK SYSTEM)

* DIMMABLE (compatible with 1-10V and DALI but fixtures cannot be dimmed individually)

Example different fixtures in one MagneTrack system

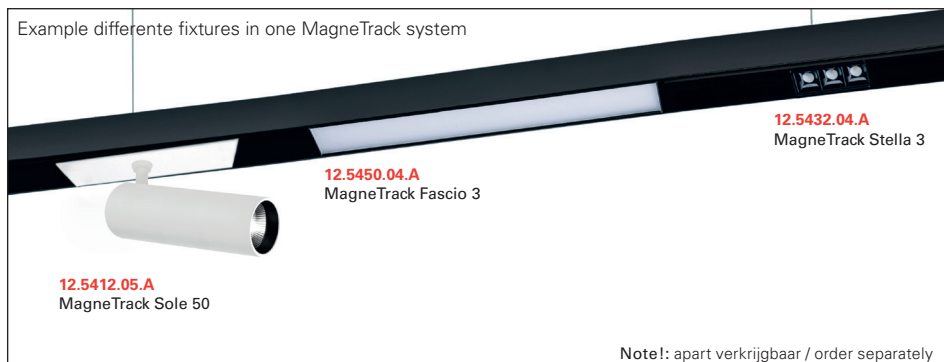

Note!: apart verkrijgbaar / order separately

<p>1 12.5410.04 Sole 35</p> <p>137x35x55mm (spot: Ø35x80mm)</p>	<p>2 12.5411.04 Sole 35 double</p> <p>137x35x55mm (spot: Ø35x80mm)</p>	<p>A 12.5401.04.A MagneTrack system (incl. end cap), Length: 1000mm</p> <p>B 12.5402.04.A MagneTrack system (incl. end cap), Length: 2000mm</p> <p>C 12.5403.04.A MagneTrack system (incl. end cap), Length: 3000mm</p> <p>W: 39x H:76mm</p>			
<p>3 12.5412.01 Sole 50</p> <p>137,5x34x55mm (spot: Ø50x140mm)</p>	<p>12.5412.04.A Sole 50</p>	<p>12.5412.05.A Sole 50</p>	<p>4 12.5432.04.A Stella 3</p> <p>94x34x56mm</p>	<p>5 12.5434.04.A Stella 6</p> <p>164x34x56mm</p>	<p>6 12.5436.04.A Stella 12</p> <p>323x34x56mm</p>
<p>7 12.5440.04.A Piega 3</p> <p>91x33.6x181mm</p>	<p>8 12.5442.04.A Piega 6</p> <p>164x34x181mm</p>				
<p>9 12.5450.04.A Fascio 3</p> <p>323x34x56mm</p>	<p>10 12.5453.04.A Fascio 6</p> <p>640x34x56mm</p>	<p>11 12.5456.04.A Fascio 9</p> <p>959x34x56mm</p>			
<p>12 12.5470.04.A MagneTrack Outside corner Incl. 2x Connecting slice Incl. 2x Connecting element</p>	<p>13 12.5471.04 MagneTrack End cap</p>	<p>14 12.5472.04.A MagneTrack Horizontal corner Incl. 2x Connecting slice Incl. 2x Connecting element</p>	<p>15 12.5473.04.A MagneTrack Inside corner Incl. 2x Connecting slice Incl. 2x Connecting element</p>	<p>16 12.5474.04.A MagneTrack Connecting slice Incl. 1x Connecting element 3-poles</p>	
<p>17 12.5476.04 MagneTrack Mounting kit (2x) Screw: M5x90mm</p>	<p>18 12.5477.04.B MagneTrack Pendant set (2x) Round plate: Ø80 x H30mm</p>	<p>19 12.5480.04 MagneTrack 1000mm Plastic track cover</p>	<p>20 12.5485.04 MagneTrack Powerboard 65mm incl 2x headers</p>	<p>21 12.5490.00 MagneTrack Connecting element 3-poles</p>	

"No rights can be derived from the information provided on this Instruction Manual. Information on the Instruction Manual has been compiled with the utmost care and is updated on a continuous basis. Nevertheless Maretti cannot guarantee that all information is free of errors, complete or fully up to date."

12.5432.COLOUR.A STELLA 3
12.5434.COLOUR.A STELLA 6
12.5436.COLOUR.A STELLA 12

MAGNETRACK STELLA SERIES

INSTRUCTIONS 4/9

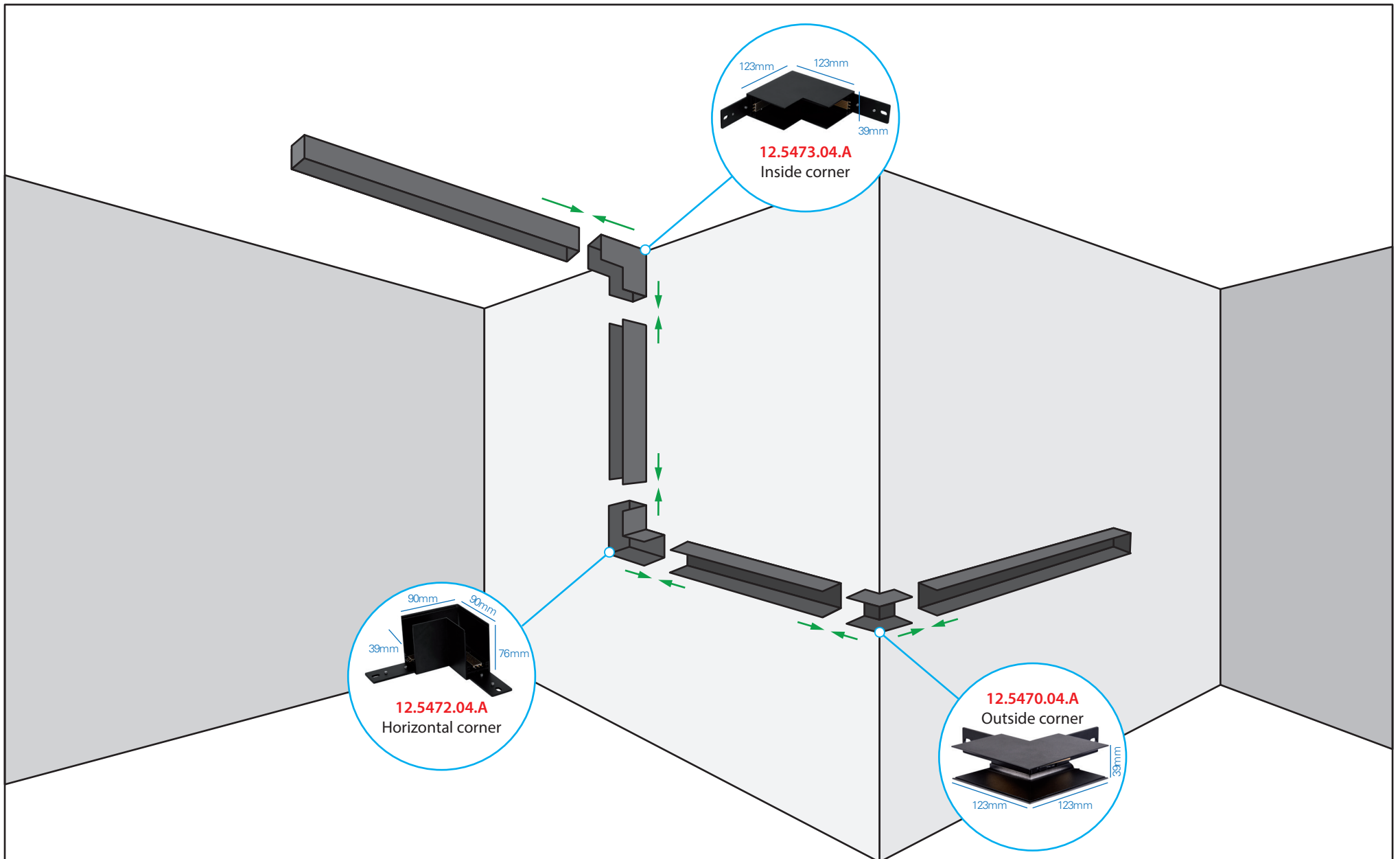

"No rights can be derived from the information provided on this Instruction Manual. Information on the Instruction Manual has been compiled with the utmost care and is updated on a continuous basis. Nevertheless Maretti cannot guarantee that all information is free of errors, complete or fully up to date."

12.5432.COLOUR.A STELLA 3
 12.5434.COLOUR.A STELLA 6
 12.5436.COLOUR.A STELLA 12

MAGNETRACK STELLA SERIES

INSTRUCTIONS 5/9

1

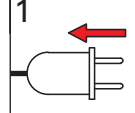

Shut off the power supply

2

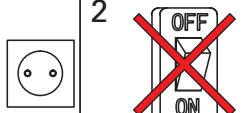

Operate without electricity

Achterkant armatuur:
 Verbinden van de Magnetrack na inkorten.

Back side fixture.
 Connecting the Magnetrack after sawing.

Magnetrack is beschikbaar in/ is available in:
 12.5401.04.A 1M
 12.5402.04.A 2M
 12.5403.04.A 3M

E: Electrical connection
 M: Mechanical connection

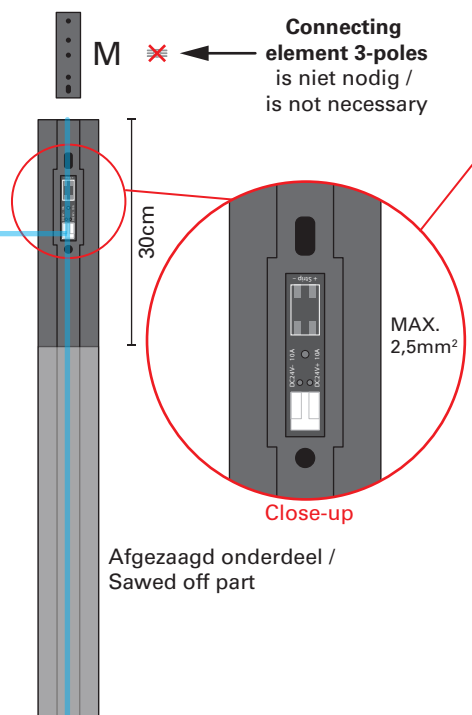
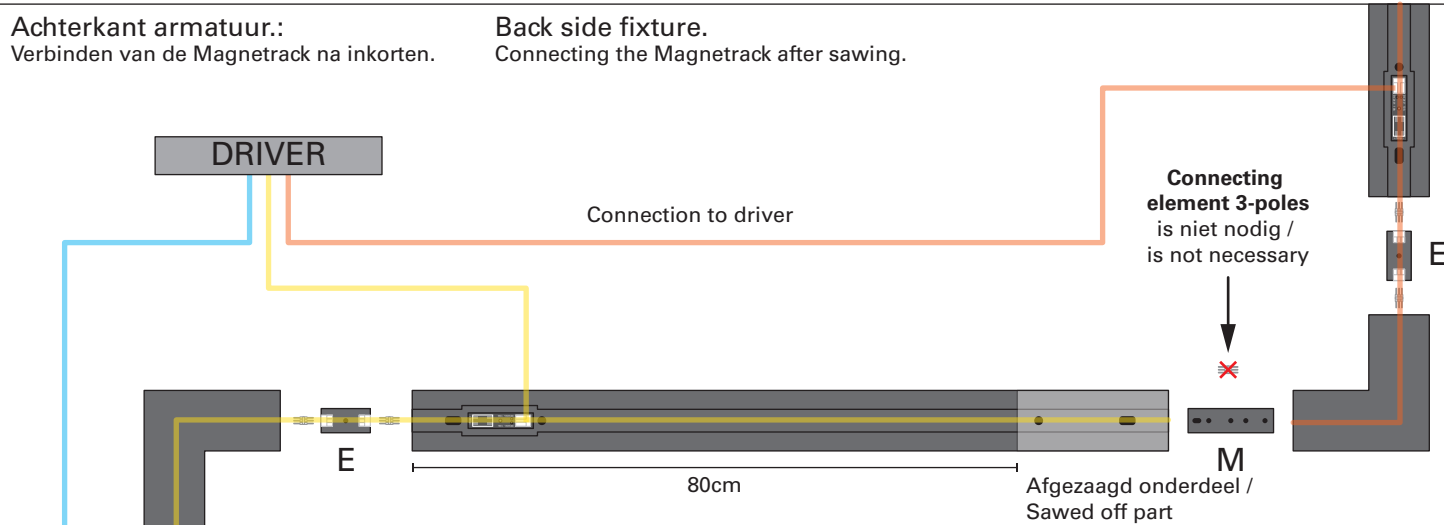

Connecting element 3-poles is not necessary / is not necessary

Type bedrading/Type of wiring

Adereindhuls / Electric wire ferrule

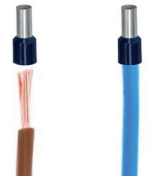

VD-draden / VD-wires

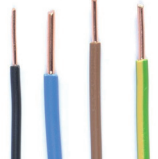

Vertinnen van draden / Tinning of wires

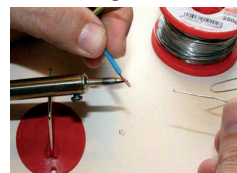

Achterkant / Back side

Het is mogelijk om de Magnetrack in te korten. Voorbeeld: Voor een wand van 3,5 meter wordt een track van 3 meter en een track van 1 meter gebruikt. De track van 1 meter dient ingekort te worden tot een lengte van 50cm. Let op: de zijde met aansluitstekkers niet afzagen!

You can adjust the size of the Magnetrack. Example: For a wall of 3.5 metres, a track of 3 metres and a track of 1 metre is used. The track of 1 metre can be adjusted to 50cms.

Note: do not saw off the side with connection plugs!

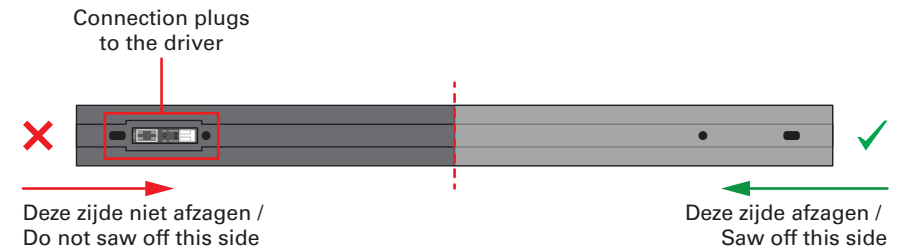

Voorkant / Front side

Dummy part
 Geen elektrisch circuit
 No electrical circuit

Electrical circuit

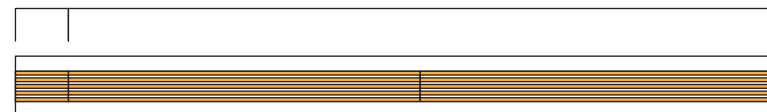

"No rights can be derived from the information provided on this Instruction Manual. Information on the Instruction Manual has been compiled with the utmost care and is updated on a continuous basis. Nevertheless Maretti cannot guarantee that all information is free of errors, complete or fully up to date."

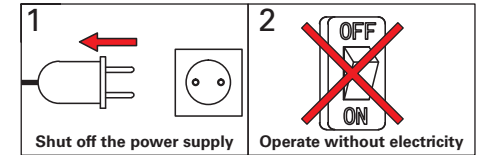

Mounting instruction: surface mounted (If you want to cut the Magnetrack please read the below information)

<p>1 Het is mogelijk om de Magnetrack in te korten. Voorbeeld: Voor een wand van 3,5 meter wordt een track van 3 meter en een track van 1 meter gebruikt. De track van 1 meter dient ingekort te worden tot een lengte van 50cm. Let op: de zijde met aansluitstekkers niet afzagen!</p> <p>You can adjust the size of the Magnetrack. Example: For a wall of 3.5 metres, a track of 3 metres and a track of 1 metre is used. The track of 1 metre can be adjusted to 50cms. Note: do not saw off the side with connection plugs!</p> <p>Connection plugs to the driver</p> <p>Do not saw off this side</p> <p>Saw off this side</p>		<p>2</p> <p>Achterkant / Back side</p> <p>Hier zagen Saw here</p> <p>1M</p> <p>0,5M</p>
<p>3</p> <p>Back side</p>	<p>4 Zorg ervoor dat u het elektrische circuit verplaatst voordat u een gat boort, om beschadiging te voorkomen. a- Verwijder het dummydeel. b- Verwijder de magneet (om het elektrische circuit te kunnen schuiven). c- Schuif het elektrische circuit naar de andere kant. d- Draai de Magnetrack om, boor een gat.</p> <p>Please make sure to move the electrical circuit before drilling a hole, to prevent damage. a- Remove the dummy part. b- Remove the magnet (to be able to slide the electrical circuit). c- Slide the electrical circuit to the other side. d- Turn over the Magnetrack, drill a hole.</p> <p>Front side</p> <p>Dummy part Geen elektrisch circuit No electrical circuit</p> <p>Electrical circuit</p>	<p>a. Dummy part Geen elektrisch circuit No electrical circuit</p> <p>b. Verwijder de magneet Remove the magnet</p> <p>Electrical circuit</p> <p>c. Electrical circuit</p>
<p>5</p> <p>Draai de Magnetrack om Turn over the Magnetrack</p> <p>Achterkant / Back side</p> <p>d. Drill a hole so you can mount the track later</p> <p>Ø9,5mm</p> <p>Zorg ervoor dat u het elektrische circuit niet aanraakt met de boor Please make sure that you do not touch the electrical circuit with the drill</p>	<p>6</p> <p>Achterkant / Back side</p> <p>Afbramen Verwijder de scherpe rand Deburring Remove sharp raised edges</p>	<p>7</p> <p>Verplaatst het elektrische circuit terug Move the electrical circuit back</p> <p>Electrical circuit</p> <p>8</p> <p>Plaats de magneet terug en dan zet het dummydeel weer op Put back the magnet and then put the dummy part back on</p>

"No rights can be derived from the information provided on this Instruction Manual. Information on the Instruction Manual has been compiled with the utmost care and is updated on a continuous basis. Nevertheless Maretti cannot guarantee that all information is free of errors, complete or fully up to date."



LET OP: Volg en bewaar deze gebruiksaanwijzing.

- Zorg ervoor dat de netspanning uitgeschakeld is voor installatie, reparatie of onderhoud. (Installatie, reparatie en onderhoud uitsluitend door gekwalificeerde personen).
- Voor reparatie of onderhoud uitsluitend originele delen gebruiken.
- Probeer het product niet zelf te demonteren en te repareren, onjuiste reparaties kunnen het product beschadigen en elektrische schokken veroorzaken wat tot ernstig letsel kan leiden. Gebruik het armatuur alleen binnenshuis.
- Het armatuur niet in vochtige of natte ruimte gebruiken.
- Uitsluitend op het etiket aangegeven lichtbronnen gebruiken.

De fabrikant aanvaardt geen enkele aansprakelijkheid voor letsel of schade als gevolg van een verkeerde toepassing van het armatuur. De fabrikant aanvaardt geen garantie in geval van het niet behandelen van de lampen volgens de richtlijnen van de fabrikant. Als er schade aan elektrische onderdelen te vinden zijn, vraag dan een elektricien om het te vervangen.

Onderhoud is behoud:

- Een goede instandhouding van het armatuur is sterk afhankelijk van omgevings- en onderhoudsfactoren. Hierop kunnen wij geen invloed uitoefenen.
- Schakel voor de zekerheid de elektriciteit uit!
- Gebruik geen agressieve, schurende of chemische schoonmaakmiddelen.

NOTE: Follow and keep this instructions manual.

- Make sure that the mains voltage is switched off before installation, repair or maintenance. (Installation, repair and maintenance only by qualified persons).
- Use only original parts for repairs or maintenance.
- Never attempt to disassemble, repair or alter the product in any way, improper repairs could damage the product causing electrical shocks which may cause serious injury.
- Use the fixture only indoors.
- Don't use the fixture in humid or wet areas.
- Use only suitable light sources indicated on the label.

The manufacturer accepts no liability for any injuries or damages resulting from the incorrect use or installation of the fixture. Any operation performed on the fixture that is not in accordance with instructions will void manufacturer's warranty. If you find any damage to the electrical parts, please ask a qualified electrician to replace it.

Maintenance is preservation:

- A good preservation of the fixture is highly dependent on environmental factors and maintenance. We cannot exercise any influence on this.
- Make sure that the mains voltage is switched off before you begin.
- Do not use aggressive, abrasive or chemical cleaners.

<p>1</p> <p>Schakel de stroomvoorziening Shut off the power supply</p>	<p>2</p> <p>Werk zonder elektriciteit Work without electricity</p>
--	--

I vorm verbinding / I shape connection

Connecting element 3-poles
Art.No: 12.5490.00

A1 Voorzien van verbindingstuk
Fitted with connecting piece

Connecting slice
Art.No:12.5474.04.A

A2 Met schroeven bevestigen
Lock back screw

A3 Compleet / Complete

Electrical connection:
When connecting the MagneTrack™ system electrically, the whole circuit is max 200W
A= 200W (A+B= max.200W)

Mechanical connection:
When connecting the MagneTrack™ system mechanically, each individual track part is max 200W

L vorm verbinding / L shape connection

MagneTrack horizontal corner not incl.
Art.No:12.5472.04.A

MagneTrack system apart te bestellen/ ordered separately:
 12.5401.04.A LENGTH: 1000mm
 12.5402.04.A LENGTH: 2000mm
 12.5403.04.A LENGTH: 3000mm

A1 Voorzien van verbindingstuk
Fitted with connecting piece

A2 Met schroeven bevestigen
Mount with screws

A3 Compleet / Complete

Installeren
Install

"No rights can be derived from the information provided on this Instruction Manual. Information on the Instruction Manual has been compiled with the utmost care and is updated on a continuous basis. Nevertheless Maretti cannot guarantee that all information is free of errors, complete or fully up to date."

12.5432.COLOUR.A STELLA 3
 12.5434.COLOUR.A STELLA 6
 12.5436.COLOUR.A STELLA 12

MAGNETRACK STELLA SERIES

INSTRUCTIONS 8/9

1	2
Schakel de stroomvoorziening Shut off the power supply	Werk zonder elektriciteit Work without electricity



MagneTrack Mounting instruction: recessed

Let op: Draag voor de installatie handschoenen.
 Note: Wear gloves before installation.

LET OP: Volg en bewaar deze gebruiksaanwijzing.
 -Zorg ervoor dat de netspanning uitgeschakeld is voor installatie, reparatie of onderhoud. (Installatie, reparatie en onderhoud uitsluitend door gekwalificeerde personen).
 -Voor reparatie of onderhoud uitsluitend originele delen gebruiken. Probeer het product niet zelf te demonteren en te repareren, onjuiste reparaties kunnen het product beschadigen en elektrische schokken veroorzaken wat tot ernstig letsel kan leiden. Gebruik het armatuur alleen binnenshuis.
 -Het armatuur niet in vochtige of natte ruimte gebruiken.
 -Uitsluitend op het etiket aangegeven lichtbronnen gebruiken.

De fabrikant aanvaardt geen enkele aansprakelijkheid voor letsel of schade als gevolg van een verkeerde toepassing van het armatuur. De fabrikant aanvaardt geen garantie in geval van het niet behandelen van de lampen volgens de richtlijnen van de fabrikant. Als er schade aan elektrische onderdelen te vinden zijn, vraag dan een elektricien om het te vervangen.

Onderhoud is behoud:

Een goede instandhouding van het armatuur is sterk afhankelijk van omgevings- en onderhoudsfactoren. Hierop kunnen wij geen invloed uitoefenen.
 -Schakel voor de zekerheid de elektriciteit uit!
 -Gebruik geen agressieve, schurende of chemische schoonmaakmiddelen.

NOTE: Follow and keep this instructions manual.

-Make sure that the mains voltage is switched off before installation, reparation or maintenance. (Installation, reparation and maintenance only by qualified persons).
 -Use only original parts for repairs or maintenance. Never attempt to disassemble, repair or alter the product in any way, improper repairs could damage the product causing electrical shocks which may cause serious injury.
 -Use the fixture only indoors.
 -Don't use the fixture in humid or wet areas.
 -Use only suitable light sources indicated on the label.

The manufacturer accepts no liability for any injuries or damages resulting from the incorrect use or installation of the fixture. Any operation performed on the fixture that is not in accordance with instructions will void manufacturer's warranty. If you find any damage to the electrical parts, please ask a qualified electrician to replace it.

Maintenance is preservation:

A good preservation of the fixture is highly dependent on environmental factors and maintenance. We cannot exercise any influence on this.
 -Make sure that the mains voltage is switched off before you begin.
 -Do not use aggressive, abrasive or chemical cleaners.

A1 Bevestig de rail met de schroef losjes aan de inbouwbeugel door enkele keren te draaien. Loosely mount the track onto the bracket by twisting the screw a few times.

Montagekit/Mounting kit
 Art.No:12.5476.04

A2 Draai the beugel 90° om deze in het plafond te plaatsen. Twist the bracket 90° to place it in the ceiling.

Driver not incl.
 DC24V

A3 Draai de beugel terug middels de schroef, om deze op het plafond te laten rusten. Twist back de bracket by using the screw, and let it rest on the ceiling.

Driver not incl.
 DC24V

A4

Driver not incl.
 DC24V

Bevestig de beugel aan het plafond met twee zelf tappende schroeven.
 Fix the bracket onto the ceiling by using two self-tapping screws.

A5 Hoogte-instelling van de Magnetrack. Track height adjustment.

Driver not incl.
 DC24V

Track verhoogd tot hetzelfde niveau met het plafond.
 Track raised to the same level with the ceiling.

A6 Installeren / Install

Driver not incl.
 DC24V

Decoratieve onderdelen die op deze locatie zijn geïnstalleerd.
 Decorative parts installed in this location.

Voorbeeld. Armaturen worden apart besteld / Example. Fixtures are ordered separately.

MagneTrack Piega 6
 Art. No: 12.5442.04.A

MagneTrack Stella 6
 Art. No.: 12.5434.04.A

MagneTrack system apart te bestellen/ ordered separately:

12.5401.04.A LENGTH: 1000mm
 12.5402.04.A LENGTH: 2000mm
 12.5403.04.A LENGTH: 3000mm

"No rights can be derived from the information provided on this Instruction Manual. Information on the Instruction Manual has been compiled with the utmost care and is updated on a continuous basis. Nevertheless Maretti cannot guarantee that all information is free of errors, complete or fully up to date."

12.5432.COLOUR.A STELLA 3
 12.5434.COLOUR.A STELLA 6
 12.5436.COLOUR.A STELLA 12

MAGNETRACK STELLA SERIES

INSTRUCTIONS 9/9

1

Schakel de stroomvoorziening
Shut off the power supply

2

Werk zonder elektriciteit
Work without electricity

MagneTrack (Ophanging/suspension)

Let op: Draag voor de installatie handschoenen.
 Note: Wear gloves before installation.



LET OP: Volg en bewaar deze gebruiksaanwijzing.
 -Zorg ervoor dat de netspanning uitgeschakeld is voor installatie, reparatie of onderhoud. (Installatie, reparatie en onderhoud uitsluitend door gekwalificeerde personen).
 -Voor reparatie of onderhoud uitsluitend originele delen gebruiken. Probeer het product niet zelf te demonteren en te repareren, onjuiste reparaties kunnen het product beschadigen en elektrische schokken veroorzaken wat tot ernstig letsel kan leiden. Gebruik het armatuur alleen binnenshuis.
 -Het armatuur niet in vochtige of natte ruimte gebruiken.
 -Uitsluitend op het etiket aangegeven lichtbronnen gebruiken.

De fabrikant aanvaardt geen enkele aansprakelijkheid voor letsel of schade als gevolg van een verkeerde toepassing van het armatuur. De fabrikant aanvaardt geen garantie in geval van het niet behandelen van de lampen volgens de richtlijnen van de fabrikant. Als er schade aan elektrische onderdelen te vinden zijn, vraag dan een elektricien om het te vervangen.

Onderhoud is behoud:

Een goede instandhouding van het armatuur is sterk afhankelijk van omgevings- en onderhoudsfactoren. Hierop kunnen wij geen invloed uitoefenen.
 -Schakel voor de zekerheid de elektriciteit uit!
 -Gebruik geen agressieve, schurende of chemische schoonmaakmiddelen.

NOTE: Follow and keep this instructions manual.

-Make sure that the mains voltage is switched off before installation, reparation or maintenance. (Installation, reparation and maintenance only by qualified persons).
 -Use only original parts for repairs or maintenance. Never attempt to disassemble, repair or alter the product in any way, improper repairs could damage the product causing electrical shocks which may cause serious injury.
 -Use the fixture only indoors.
 -Don't use the fixture in humid or wet areas.
 -Use only suitable light sources indicated on the label.

The manufacturer accepts no liability for any injuries or damages resulting from the incorrect use or installation of the fixture. Any operation performed on the fixture that is not in accordance with instructions will void manufacturer's warranty. If you find any damage to the electrical parts, please ask a qualified electrician to replace it.

Maintenance is preservation:

A good preservation of the fixture is highly dependent on environmental factors and maintenance. We cannot exercise any influence on this.
 -Make sure that the mains voltage is switched off before you begin.
 -Do not use aggressive, abrasive or chemical cleaners.

A1 Bovenaanzicht / Top view

Pendant set not incl.
 Art. No: 12.5477.04.B

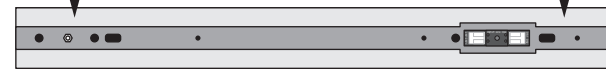
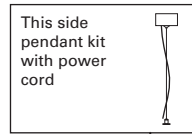
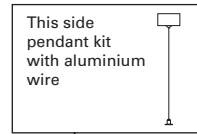

A2

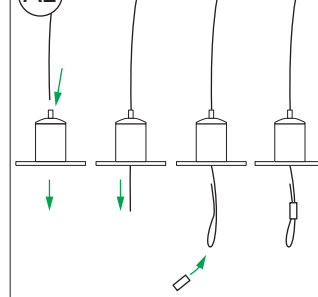

A3

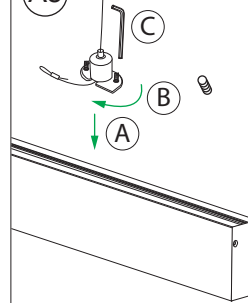

Bovenaanzicht / Top view Close-up

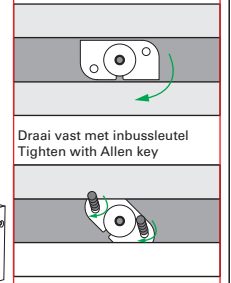

A4 Bovenaanzicht / Top view Close-up



Trekontlaster incl. bij de Magnettrack
 Strain relief incl. with the Magnettrack

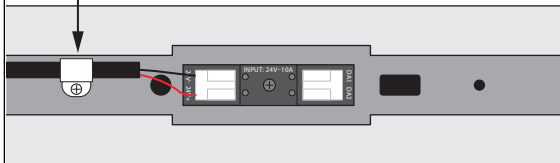

A5

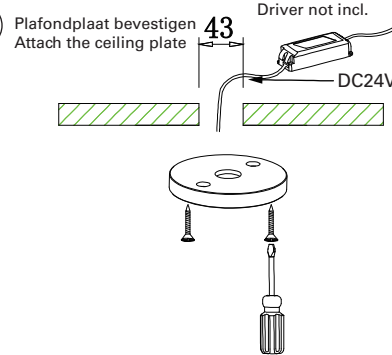

A6

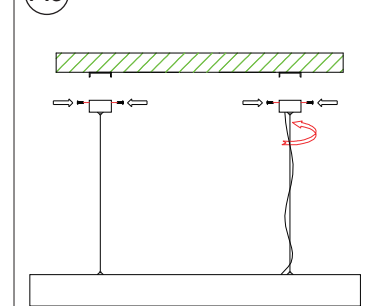

A7

Pas de lengte van de draad aan om de installatie te voltooien.
 Adjust the length of wire to complete the installation.

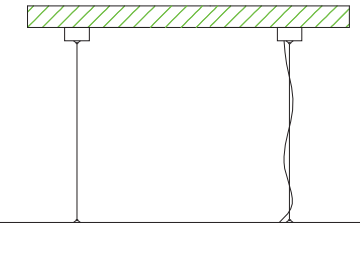

Voorbeeld. Armaturen worden apart besteld / Example. Fixtures are ordered separately.

MagneTrack Piega 6
 Art. No: 12.5442.04.A

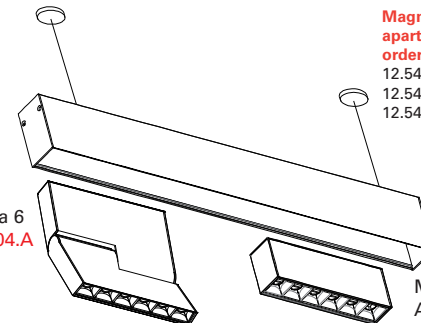

MagneTrack system apart te bestellen/ ordered separately:
 12.5401.04.A LENGTH: 1000mm
 12.5402.04.A LENGTH: 2000mm
 12.5403.04.A LENGTH: 3000mm

MagneTrack Stella 6
 Art. No.: 12.5434.04.A

"No rights can be derived from the information provided on this Instruction Manual. Information on the Instruction Manual has been compiled with the utmost care and is updated on a continuous basis. Nevertheless Maretti cannot guarantee that all information is free of errors, complete or fully up to date."