



MARETTI

L I G H T I N G



Maretti Lighting
Bolderweg 7

1332 AX Almere
the Netherlands

T +31 (0) 36 532 66 12

E info@maretti.com
W www.maretti.com

Maretti Lighting is well-known in the World of interior design. In businesses, homes, store chains, and hospitality facilities all over the world, Maretti is unmistakable present with its project lighting that does more than just provide light. We make lighting an essential part of the interior. Maretti stands for stylish top quality and trendsetting design, modern, timeless and most of all, original.

Maretti Lighting works with all the top brands in the lighting industry, but we are especially notable for our own large product line and introduce our own brand name "Maretti". Our production team distinguishes itself time and time again with unique innovations from our own atelier and therefore our projects exude an entirely unique identity.

© Copyright Maretti Projectverlichting.

Our IM was made with the greatest of care. Nevertheless, the colours displayed in the IM may differ slightly from the real colours because of the printing process. Colour, size and range are subject to change. Nothing from this IM may be copied, reproduced and/or published by print, photocopy or in any other way without Maretti Lighting's written permission. All product and design copyrights belong to Maretti Lighting.

GUARANTEE TERMS AND CONDITIONS

The other party should inspect the delivered items immediately upon receipt with regard to its soundness. Entitlements to repair or replacement only exist if the other party

- In the case of visible defects, informs MPV of them immediately.

- In the case of defects that are not visible, informs MPV in writing of the defects, within 2 working days after the day the defects were found, or in all reason could have been found and furthermore demonstrates that the MPV instructions for use, maintenance and operation were followed, whilst the defects are not the consequence of normal wear and tear, misuse, negligence, accident, exceeding the limits prescribed by the MPV or by the legal safety regulations, or, in the case of a repair or change without MPV's consent or the consent of its recognised repairer, there will be no entitlement to repairs or replacement. The parts that have to be replaced must be made available free of charge to MPV. Noncompliance by the other party to one or more of its obligations will release MPV of all its guarantee obligations. In the case of assembly of the other party's own products by Maretti, MPV will release itself from all guarantee stipulations. Moreover, our general delivery terms and conditions are applicable. These can be obtained from Maretti or can be downloaded from www.maretti.com

The installation must be done by a competent installer. Maretti recommends that your (outside) lighting and fixtures are inspected and maintained annually.

D: Für Garantiebedingungen bitte lesen Sie unsere Webseite www.maretti.com
E: Consulte nuestro sitio web para los condiciones de garantía www.maretti.com
FR: Consultez notre site web pour les conditions de garantie www.maretti.com
NL: Voor garantievoorwaarden zie onze website www.maretti.com

12.4281.COLOUR 1M
12.4282.COLOUR 2M
12.4283.COLOUR 3M

MAR-TRACK

3-PHASE SERIES

ACCESSORIES (SEE PAGE 2)
THEY ARE ORDERED SEPARATELY
1/6

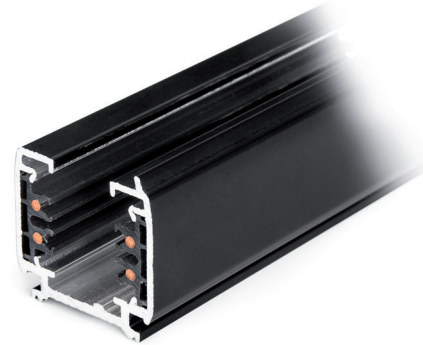

BLACK WHITE

04 05

230V	VOLTAGE
	INDOOR
	CE MARK

Max. wattage:
16A voor elk circuit / for each circuit.

De wattage limiet voor elk circuit
The wattage limit for each circuit:
230V*16A=3680 wattage.

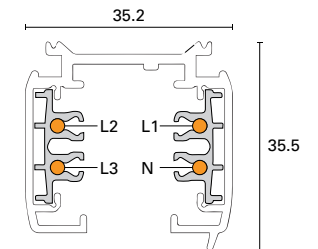

LET OP:

- Volg en bewaar deze gebruiksaanwijzing.
- Zorg ervoor dat de netspanning uitgeschakeld is voor installatie of onderhoud. (Installatie en onderhoud uitsluitend door gekwalificeerde personen).
- Gebruik het armatuur alleen binnenshuis.
- Het armatuur niet in vochtige of natte ruimte gebruiken.

De fabrikant aanvaardt geen enkele aansprakelijkheid voor letsel of schade als gevolg van een verkeerde toepassing van het armatuur. Als er schade aan elektrische onderdelen te vinden zijn, vraag dan een elektricien om het te vervangen.

Onderhoud is behoud:

Een goede instandhouding van het armatuur is sterk afhankelijk van omgevings- en onderhoudsfactoren. Hierop kunnen wij geen invloed uitoefenen.

- Schakel voor de zekerheid de elektriciteit uit!
- Gebruik geen bijtende, chemische middelen of schurende schoonmaakmiddelen.

NOTE:

- Follow and keep this instructions manual.
- Make sure that the mains voltage is switched off for installation or maintenance. (Installation and maintenance only by qualified persons).
- Use the fixture only indoors.
- Don't use the fixture in humid or wet areas.

The manufacturer accepts no liability for any injuries or damages resulting from the incorrect use or installation of the fixture. If you find any damage to the electrical parts, please ask a qualified electrician to replace it.

Maintenance is preservation:

A good preservation of the fixture is highly dependent on environmental factors and maintenance. We cannot exercise any influence on this.

- Make sure that the mains voltage is switched off before you begin.
- Do not use strong, chemicals or abrasive cleaners.

12.4281.COLOUR 1M
 12.4282.COLOUR 2M
 12.4283.COLOUR 3M

MAR-TRACK 3-PHASE SERIES

TRACK SYSTEM ACCESSORIES ARE ORDERED SEPARATELY

2/6

MAR-TRACK 3-PHASE Electrical mini joiner

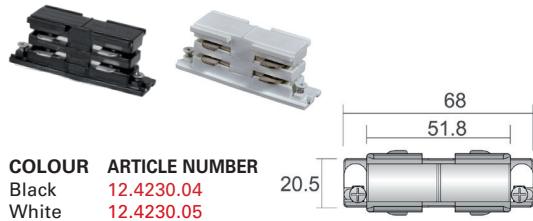

COLOUR	ARTICLE NUMBER
Black	12.4230.04
White	12.4230.05

MAR-TRACK 3-PHASE Mechanical mini joiner

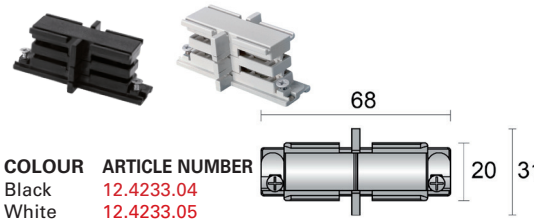

COLOUR	ARTICLE NUMBER
Black	12.4233.04
White	12.4233.05

MAR-TRACK 3-PHASE Electrical adapter

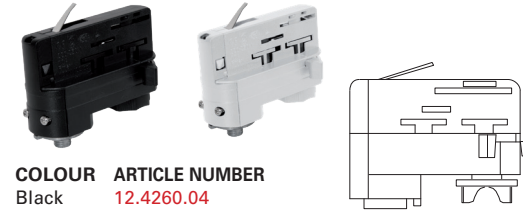

COLOUR	ARTICLE NUMBER
Black	12.4260.04
White	12.4260.05

MAR-TRACK 3-PHASE Electrical adapter

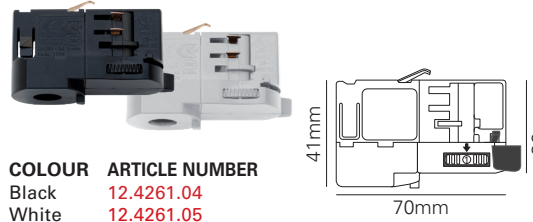

COLOUR	ARTICLE NUMBER
Black	12.4261.04
White	12.4261.05

MAR-TRACK 3-PHASE Mechanical adapter

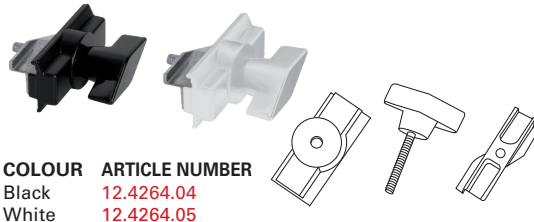

COLOUR	ARTICLE NUMBER
Black	12.4264.04
White	12.4264.05

MAR-TRACK 3-PHASE Suspension kit EZ-click (1,5M wire)



COLOUR	ARTICLE NUMBER
Black	12.4272.04
White	12.4272.05

**INCL.
1,5M WIRE**

MAR-TRACK 3-PHASE Suspension kit EZ-click (5M wire)



COLOUR	ARTICLE NUMBER
Black	12.4274.04
White	12.4274.05

**INCL.
5M WIRE**

MAR-TRACK 3-PHASE Slot connection tool

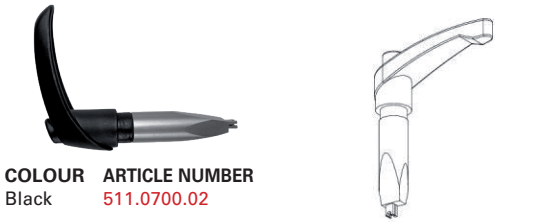

COLOUR	ARTICLE NUMBER
Black	511.0700.02

MAR-TRACK 3-PHASE Mounting kit



COLOUR	ARTICLE NUMBER
Black	12.4275.04
White	12.4275.05

MAR-TRACK 3-PHASE Reinforcement plate

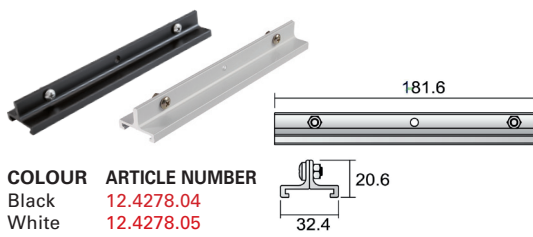

COLOUR	ARTICLE NUMBER
Black	12.4278.04
White	12.4278.05

MAR-TRACK 3-PHASE Live End connector LEFT

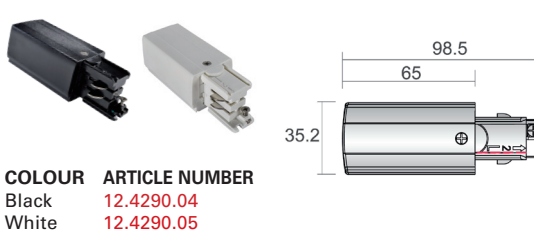

COLOUR	ARTICLE NUMBER
Black	12.4290.04
White	12.4290.05

"No rights can be derived from the information provided on this Instruction Manual. Information on the Instruction Manual has been compiled with the utmost care and is updated on a continuous basis. Nevertheless Maretti cannot guarantee that all information is free of errors, complete or fully up to date."

12.4281.COLOUR 1M
 12.4282.COLOUR 2M
 12.4283.COLOUR 3M

MAR-TRACK 3-PHASE SERIES

TRACK SYSTEM ACCESSORIES ARE ORDERED SEPARATELY

3/6

MAR-TRACK 3-PHASE Live End connector RIGHT

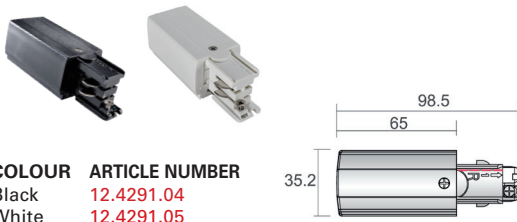

COLOUR ARTICLE NUMBER

Black	12.4291.04
White	12.4291.05

Dimensions: 98.5, 65, 35.2

MAR-TRACK 3-PHASE Straight connector

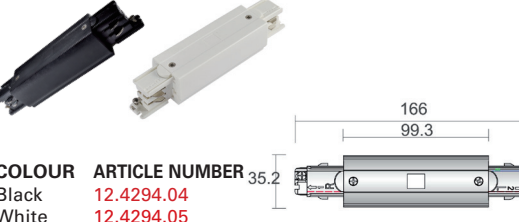

COLOUR ARTICLE NUMBER

Black	12.4294.04
White	12.4294.05

Dimensions: 166, 99.3, 35.2

MAR-TRACK 3-PHASE End cap



COLOUR ARTICLE NUMBER

Black	12.4298.04
White	12.4298.05

Dimensions: 31.3, 35.2

MAR-TRACK 3-PHASE L-connector LEFT (90° angle)



COLOUR ARTICLE NUMBER

Black	12.4304.04
White	12.4304.05

Dimensions: 100.7, 67.4

MAR-TRACK 3-PHASE L-connector right (90° angle)



COLOUR ARTICLE NUMBER

Black	12.4305.04
White	12.4305.05

Dimensions: 100.7, 67.4

MAR-TRACK 3-PHASE Flexible connector

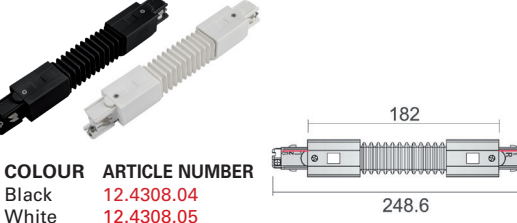

COLOUR ARTICLE NUMBER

Black	12.4308.04
White	12.4308.05

Dimensions: 182, 248.6

MAR-TRACK 3-PHASE T-connector LEFT

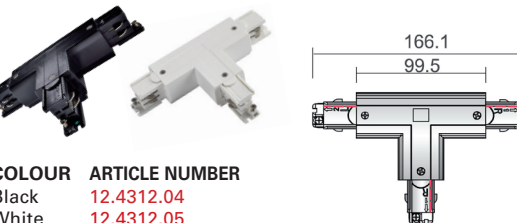

COLOUR ARTICLE NUMBER

Black	12.4312.04
White	12.4312.05

Dimensions: 166.1, 99.5

MAR-TRACK 3-PHASE T-connector RIGHT

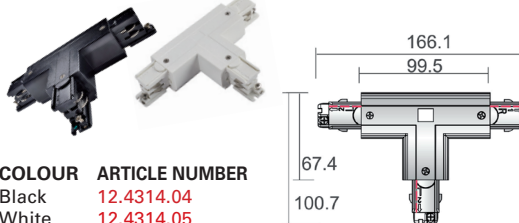

COLOUR ARTICLE NUMBER

Black	12.4314.04
White	12.4314.05

Dimensions: 166.1, 99.5, 67.4, 100.7

MAR-TRACK 3-PHASE X-connector

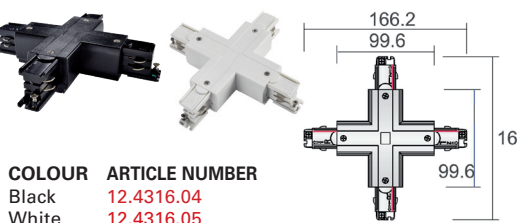

COLOUR ARTICLE NUMBER

Black	12.4316.04
White	12.4316.05

Dimensions: 166.2, 99.6, 166.2, 99.6

MONOPOINT DALI FOR 3-PHASE ADAPTER

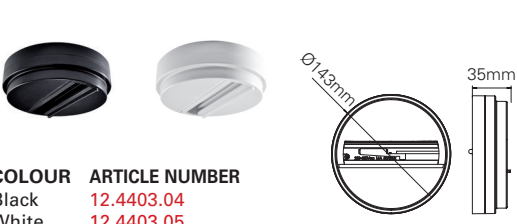

COLOUR ARTICLE NUMBER

Black	12.4403.04
White	12.4403.05

Dimensions: Ø143mm, 35mm

MAR-TRACK COVER STRIP 3M BLACK

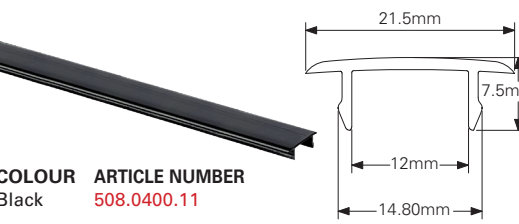

COLOUR ARTICLE NUMBER

Black	508.0400.11
-------	-------------

Dimensions: 21.5mm, 7.5mm, 12mm, 14.80mm

"No rights can be derived from the information provided on this Instruction Manual. Information on the Instruction Manual has been compiled with the utmost care and is updated on a continuous basis. Nevertheless Maretti cannot guarantee that all information is free of errors, complete or fully up to date."

- 12.4281.COLOUR 1M
- 12.4282.COLOUR 2M
- 12.4283.COLOUR 3M

MAR-TRACK 3-PHASE SERIES

EXAMPLE OF A TRACK SYSTEM CONNECTION DIAGRAM

4/5



UIT OFF

Schakel altijd eerst de stroom uit voordat u installatie-, onderhoud of reparatiewerkzaamheden uitvoert.

Always switch off the mains voltage before carrying out installation, maintenance and repair work.

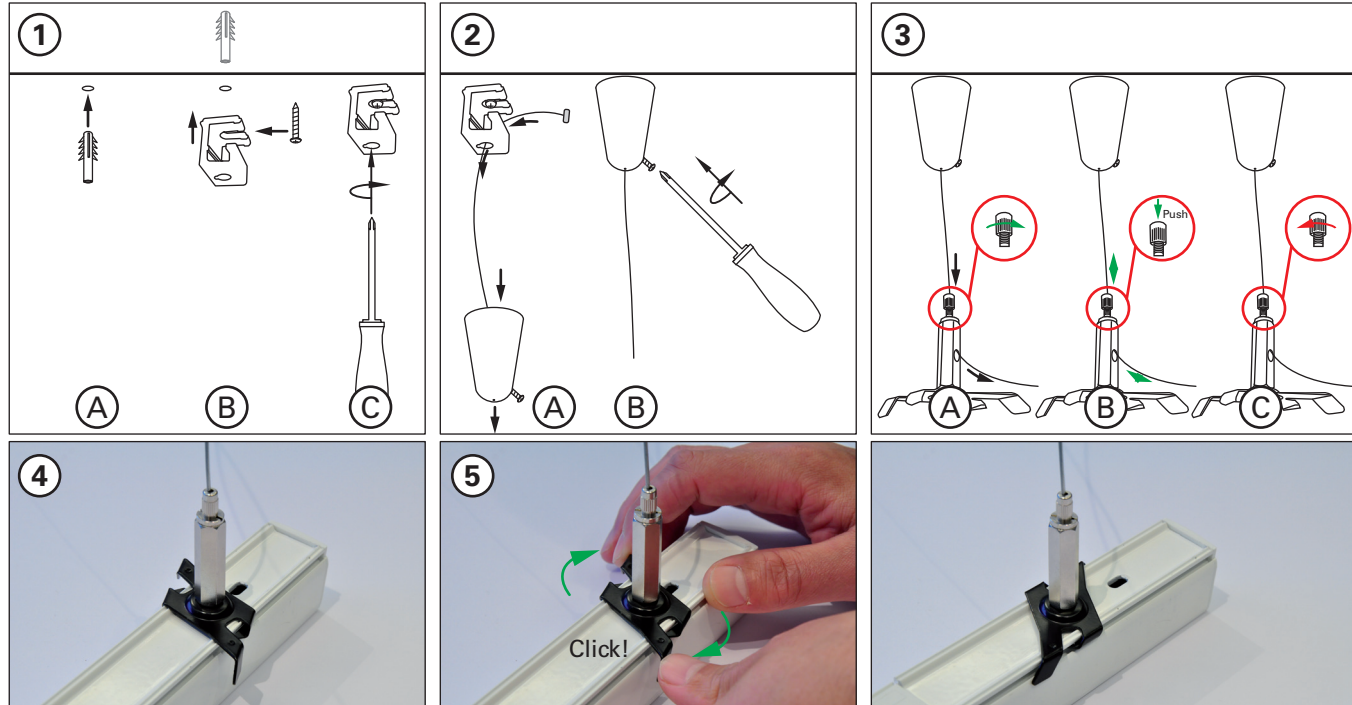
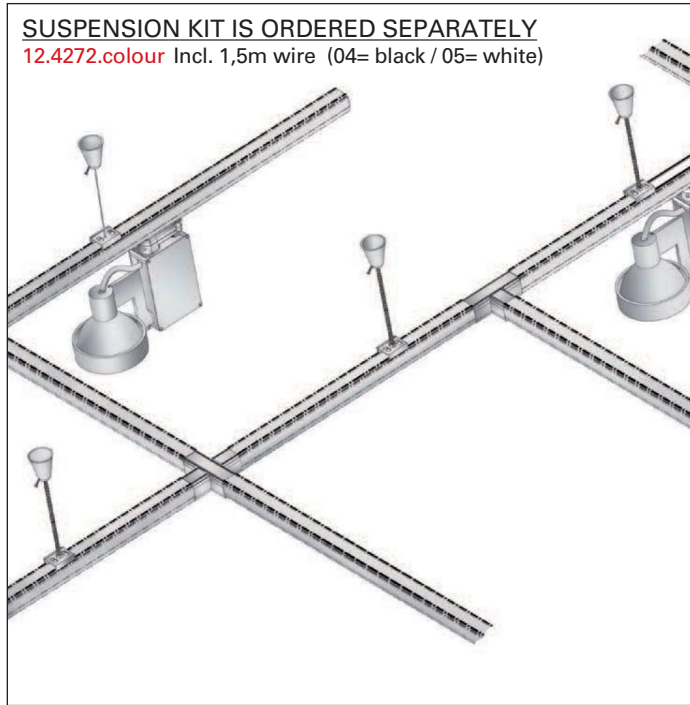

MAR-TRACK 3-PHASE:

- 12.4281.colour 1 meter (04= black / 05= white)
- 12.4282.colour 2 meters (04= black / 05= white)
- 12.4283.colour 3 meters (04= black / 05= white)

35.2

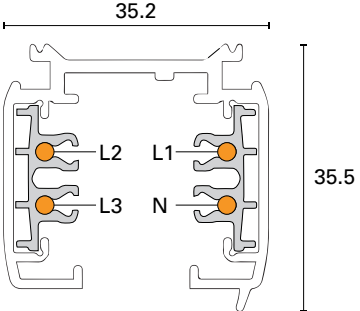

35.5

BLACK WHITE

04 **05**

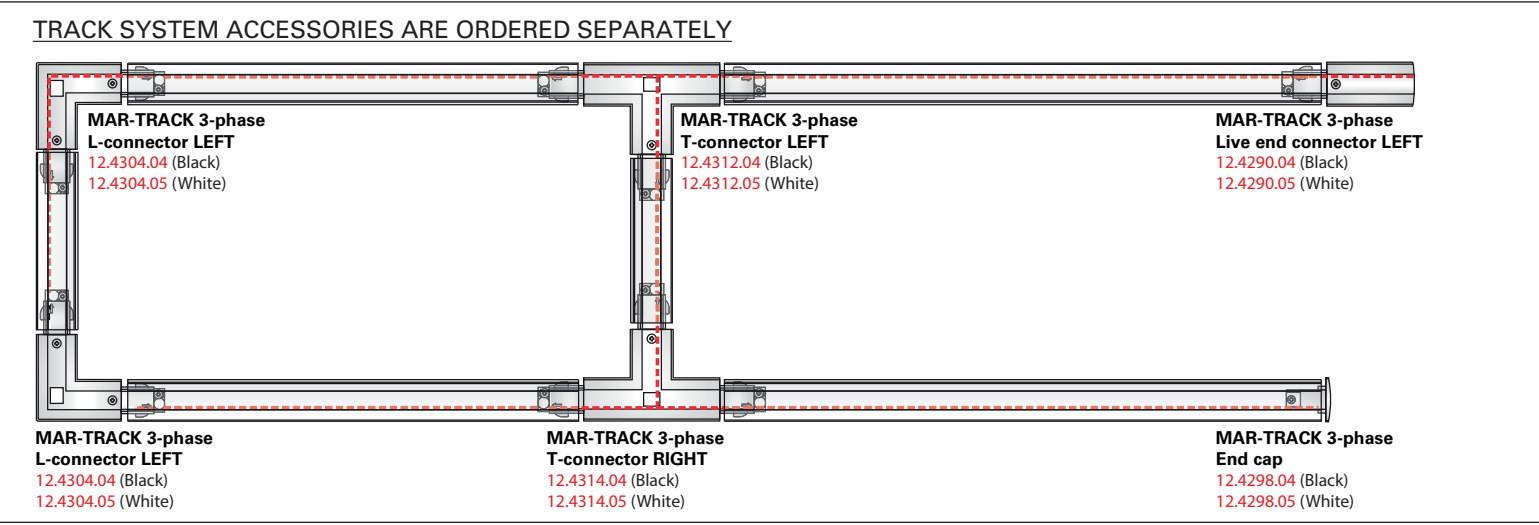

"No rights can be derived from the information provided on this Instruction Manual. Information on the Instruction Manual has been compiled with the utmost care and is updated on a continuous basis. Nevertheless Maretti cannot guarantee that all information is free of errors, complete or fully up to date."

12.4281.COLOUR 1M
 12.4282.COLOUR 2M
 12.4283.COLOUR 3M

MAR-TRACK 3-PHASE SERIES

INSTRUCTION

5/5



BELANGRIJKE INFORMATIE:

- Zorgvuldig lezen voor de installatie van het railsysteem.
- System cijfer: 400V/16A 3-phase (11KW) of 1-phase 3 circuit 230V/16A (3x3.7 KW).
- ALLEEN VOOR BINNEN GEBRUIK en in droge en stofvrije ruimten. Het systeem heeft IP20.
- Het systeem NIET elektrisch of fysiek overbelasten.
- Gebruik alleen producten die bestemd zijn voor gebruik met dit product of compatibel.
- Forceer de adapter nooit in een positie of verbinding.
- Overmatige kracht is normaal gesproken een aanwijzing voor andere problemen.
- Alle elektrische aansluitingen die het railsysteem voeden, moeten worden uitgevoerd als vaste installatie.
- Alle afmetingen in mm indien niet vermeld.
- Mag alleen worden geïnstalleerd door een erkend installateur.
- NOOIT voeding van de baan op meer dan één aansluitpunt!

IMPORTANT INFORMATION:

- Read carefully before install the track system.
- System rating: 400V/16A 3-phase (11KW) or 1-phase 3 circuit 230V/16A (3x3.7 KW).
- FOR INDOOR USE ONLY and in dry and dust free spaces. System is rated IP20.
- Do NOT electrically or physically overload system.
- Use only products intended for operation with this product or compatible.
- Never force the adaptor into a position or connection. Excessive force is normally an indication of other problems.
- All electrical connections power feeding the track must be carried out as fixed installation.
- All dimensions in mm if not stated.
- Shall only be installed by authorized installer.
- NEVER power supply the track at more than one connection point!

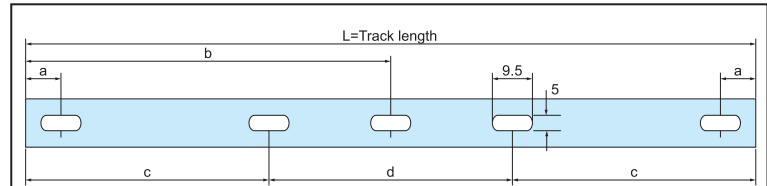
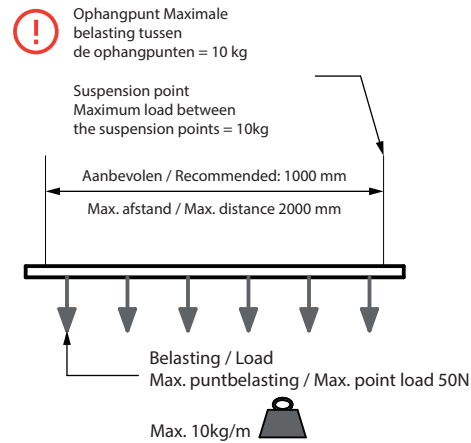

L / mm	a / mm	b / mm	c / mm	d / mm
1000	120			
2000	120	863		
3000	120		909	2086
4000	120		1242	2753

Niet geleverd door Maretti
Not supplied by Maretti

Gebruik boorschroeven voor metalen beugels en metalen / houten schroeven voor zachtere materialen. Bepaal de grootte van de schroef om de lading te ondersteunen. Gebruik schroeven in alle gestante sleuven en draai ze stevig vast. Maximale schroefkop Ø8mm

Use drilling screws for metal brackets and metal/wooden screws for softer materials. Dimension the size of the screw to support the load. Use screws in all punched slots and tighten them firmly. Maximum screw head Ø8mm

De sleutelcode in de feeder moet overeenkomen
The key code in the feeder must be a match

Leid de kabel door de kabelinvoer.
Let op: deze installatie moet voldoen met de vereisten voor vaste installatie.

Route the cable through the cable entry.
Remember: This installation must comply with the requirements for fixed installation.

Optioneel toegangspunt
Optional entry

Nadat u de connector op de rail hebt bevestigd, draait u de schroef stevig vast.

After join the connector to the track, tighten the screw firmly.

Snij baan op juiste lengte en maak de snijkant nauwkeurig schoon.
Cut track to correct length and clean the cutting edge accurate.

Open zijde aan de onderkant
Open side at the bottom

Montagerail en connector vóór installatie in de plafondgleuf.
Gebruik schroeven in alle sleuven in het profiel en zorg ervoor dat ze stevig worden vastgedraaid.

Assembly track and connector before install into the ceiling slot.
Use screws in all slots in the profile and be sure to tighten them firmly.

sleufopening / Slot opening 37,38mm

"No rights can be derived from the information provided on this Instruction Manual. Information on the Instruction Manual has been compiled with the utmost care and is updated on a continuous basis. Nevertheless Maretti cannot guarantee that all information is free of errors, complete or fully up to date."

12.4281.COLOUR 1M
 12.4282.COLOUR 2M
 12.4283.COLOUR 3M

MAR-TRACK 3-PHASE SERIES

INSTRUCTION

6/5

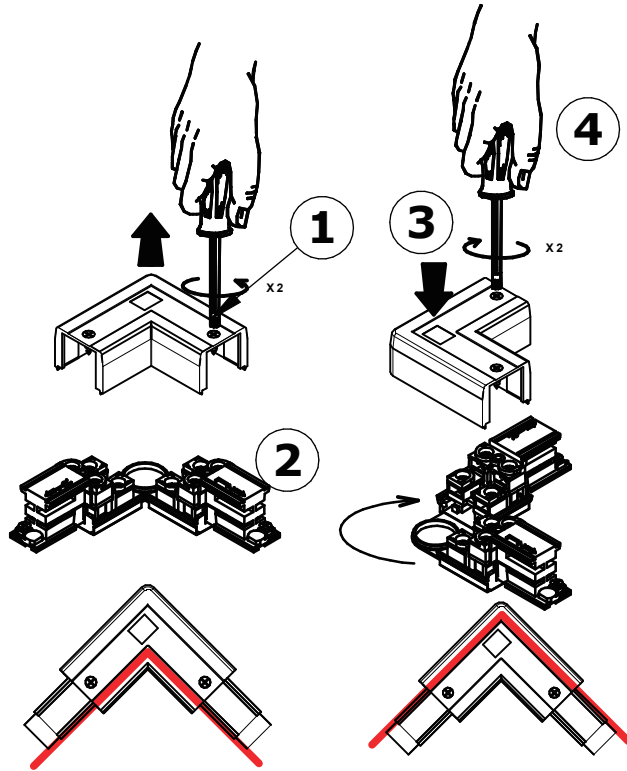

Omkeerbare L- en T-connector is mogelijk
 omdraaien om overeen te komen met de richting van het profiel.

Om dit te doen:

1. Draai de schroeven los die de kap vasthouden en verwijder de kap.
2. Draai de L-connector 180 of de T-connector 90.
3. Plaats het deksel terug en draai de schroeven vast.

Reversible L and T connector is possible
 to turn around to match profile direction.

To do so:

1. Unscrew the screws holding the cover and remove the cover.
2. Turn the L connector 180 or the T connector 90.
3. Put back the cover and tighten the screws.

Zorg ervoor dat u de profielrichting op alle verbindingpunten afstemt. Be sure to match the profile direction on all connection points.

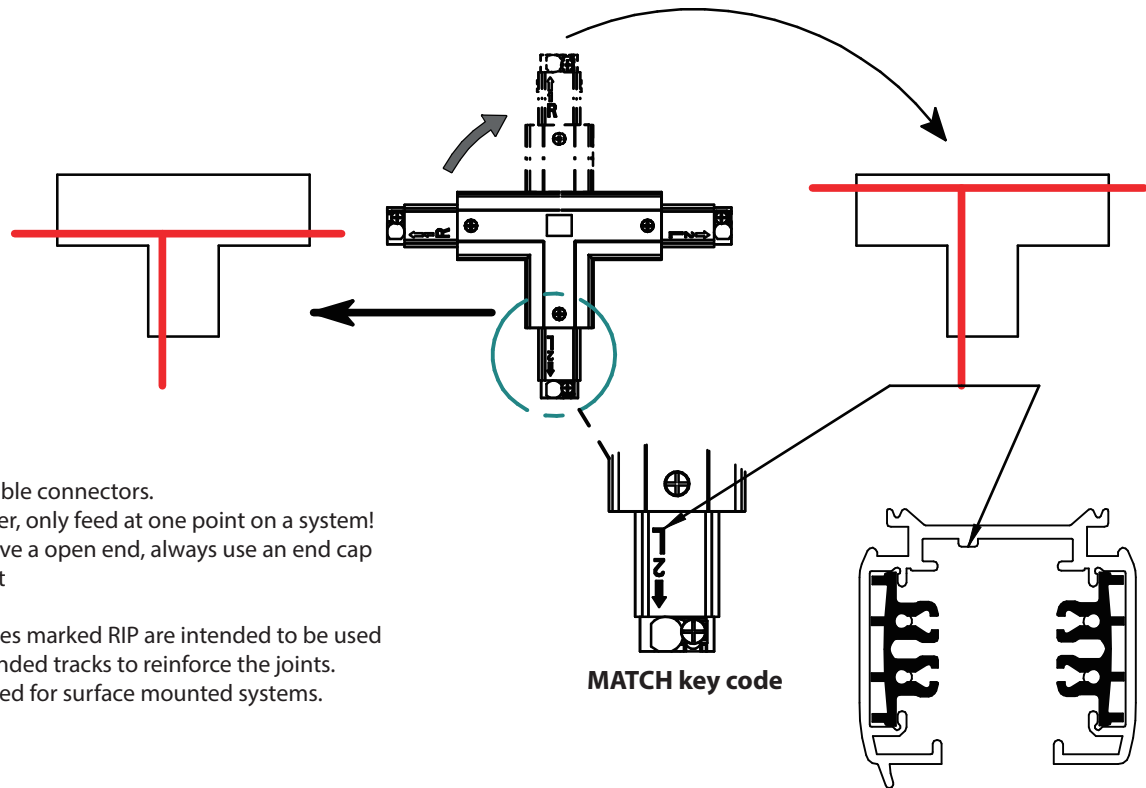

* = Voedbare connectoren.

Denk eraan, voer maar op één punt op een systeem!
 Laat nooit een open uiteinde achter, gebruik altijd een
 end cap om het te bedekken

Accessoires gemarkeerd met RIP zijn bedoeld om te worden
 gebruikt op hangende rails om de gewrichten te versterken.
 Niet nodig voor op het oppervlak gemonteerde systemen.

* = Feedable connectors.

Remember, only feed at one point on a system!
 Never leave a open end, always use an end cap
 to cover it

Accessories marked RIP are intended to be used
 on suspended tracks to reinforce the joints.
 Not needed for surface mounted systems.