



Maretti Lighting
Bolderweg 7

1332 AX Almere
the Netherlands

T +31 (0) 36 532 66 12
F +31 (0) 36 532 17 35

E info@maretti.com
W www.maretti.com

Maretti Lighting is well-known in the World of interior design. In businesses, homes, store chains, and hospitality facilities all over the world, Maretti is an unmistakable presence with its project lighting that does more than just provide light. We make lighting an essential part of the interior. Maretti stands for stylish top quality and trendsetting design, modern, timeless and most of all, original.

Maretti Lighting works with all the top brands in the lighting industry, but we are especially notable for our own large product line and introduce our own brand name "Maretti". Our production team distinguishes itself time and time again with unique innovations from our own atelier and therefore our projects exude an entirely unique identity.

© Copyright Maretti Projectverlichting.

Our IM was made with the greatest of care. Nevertheless, the colours displayed in the IM may differ slightly from the real colours because of the printing process. Colour, size and range are subject to change. Nothing from this IM may be copied, reproduced and/or published by print, photocopy or in any other way without Maretti Lighting's written permission. All product and design copyrights belong to Maretti Lighting.

GUARANTEE TERMS AND CONDITIONS

The other party should inspect the delivered items immediately upon receipt with regard to its soundness. Entitlements to repair or replacement only exist if the other party

- In the case of visible defects, informs MPV of them immediately.

- In the case of defects that are not visible, informs MPV in writing of the defects, within 2 working days after the day the defects were found, or in all reason could have been found and furthermore demonstrates that the MPV instructions for use, maintenance and operation were followed, whilst the defects are not the consequence of normal wear and tear, misuse, negligence, accident, exceeding the limits prescribed by the MPV or by the legal safety regulations, or, in the case of a repair or change without MPV's consent or the consent of its recognised repairer, there will be no entitlement to repairs or replacement. The parts that have to be replaced must be made available free of charge to MPV. Noncompliance by the other party to one or more of its obligations will release MPV of all its guarantee obligations. In the case of assembly of the other party's own products by Maretti, MPV will release itself from all guarantee stipulations. Moreover, our general delivery terms and conditions are applicable. These can be obtained from Maretti or can be downloaded from www.maretti.com

The installation must be done by a competent installer. Maretti recommends that your (outside) lighting and fixtures are inspected and maintained annually.

D: Für Garantiebedingungen bitte lesen Sie unsere Webseite www.maretti.com
E: Consulte nuestro sitio web para los condiciones de garantía www.maretti.com
FR: Consultez notre site web pour les conditions de garantie www.maretti.com
NL: Voor garantievoorwaarden zie onze website www.maretti.com

11.1811.COLOUR.A
11.1812.COLOUR.A
11.1813.COLOUR.A
11.1814.COLOUR.A

SQUARE TRIMLESS AR111

With adjustable installation kit

1/5



11.1811



11.1812



11.1813











11.1814

BLACK WHITE

04













05

12V	VOLTAGE	20	IP RATING		GEAR NOT INCLUDED		
50W	WATTAGE MAX.		INDOOR		ADJUSTABLE INSTALLATION KIT		
	BULB NOT INCLUDED		12V, 2-PINS PLUG & PLAY		TWISTING		
G53	SOCKET		CABLE 300MM		CE MARK		

11.1811.COLOUR.A
 11.1812.COLOUR.A
 11.1813.COLOUR.A
 11.1814.COLOUR.A

SQUARE TRIMLESS AR111

with adjustable installation kit
 2/5

ACCESSORIES SEPARATE ORDE	BULBS		DRIVER		
	BULBS		DRIVER		
	21.8060.82 PALOMA LED AR111 15W 350mA 24° 780lm 2700K Ra82		19.7550.05 LED DRIVER FOR PALOMA 350mA		
TRIM ACCESSORIES					
11.1816.04 BLACK TRIM FOR		11.1811 (1 LIGHT)	BLACK TRIMS	WHITE TRIMS	GREY TRIMS
11.1816.05 WHITE TRIM FOR		11.1811 (1 LIGHT)			
11.1816.07 GREY TRIM FOR		11.1811 (1 LIGHT)			
11.1817.04 BLACK TRIM FOR		11.1812 (2 LIGHT)			
11.1817.05 WHITE TRIM FOR		11.1812 (2 LIGHT)			
11.1817.07 GREY TRIM FOR		11.1812 (2 LIGHT)			
11.1818.04 BLACK TRIM FOR		11.1813 (3 LIGHT)			
11.1818.05 WHITE TRIM FOR		11.1813 (3 LIGHT)			
11.1818.07 GREY TRIM FOR		11.1813 (3 LIGHT)			
11.1819.04 BLACK TRIM FOR		11.1814 (4 LIGHT)			
11.1819.05 WHITE TRIM FOR		11.1814 (4 LIGHT)			
11.1819.07 GREY TRIM FOR		11.1814 (4 LIGHT)			
P&P CABLES		INSTALLATION KIT			
70.7510.04 P&P CABLE 300MM		11.1807 ADJ. KIT 1 LIGHT (BLACK, WHITE)			
70.7515.04 P&P CABLE 700MM		11.1808 ADJ. KIT 2 LIGHTS (BLACK, WHITE)			
70.7520.04 P&P CABLE 1300MM		11.1809 ADJ. KIT 3 LIGHTS (BLACK, WHITE)			
70.7525.04 P&P CABLE 1900MM		11.1810 ADJ. KIT 4 LIGHTS (BLACK, WHITE)			

MARETTI

11.1811
11.1812
11.1813
11.1814

 This luminaire is compatible with bulbs of the energy classes:

A++
A+
A
B
C
D
E

874/2012 



LET OP:

- Volg en bewaar deze gebruiksaanwijzing.
- Zorg ervoor dat de netspanning uitgeschakeld is voor installatie, reparatie of onderhoud. (Installatie, reparatie en onderhoud uitsluitend door gekwalificeerde personen).
- Voor reparatie of onderhoud uitsluitend originele delen gebruiken.
- Gebruik het armatuur alleen binnenshuis. Het armatuur niet in vochtige of natte ruimte gebruiken.
- Uitsluitend op het etiket aangegeven lichtbronnen gebruiken.

Wanneer u een spot inbouwt moet u rekening houden met de warmte en dus rekening houden met extra inbouwruimte rond je armatuur om eventuele schade te voorkomen.

De fabrikant aanvaardt geen enkele aansprakelijkheid voor letsel of schade als gevolg van een verkeerde toepassing van het armatuur. De fabrikant aanvaardt geen garantie in geval van het niet behandelen van de lampen volgens de richtlijnen van de fabrikant. Als er schade aan elektrische onderdelen te vinden zijn, vraag dan een electricien om het te vervangen.

Onderhoud is behoud:

Een goede instandhouding van het armatuur is sterk afhankelijk van omgevings- en onderhoudsfactoren. Hierop kunnen wij geen invloed uitoefenen.

- Schakel voor de zekerheid de elektriciteit uit!
- Gebruik geen bijtende, chemische middelen of schurende schoonmaakmiddelen.

NOTE:

- Follow and keep this instructions manual.
- Make sure that the mains voltage is switched off for installation, repair or maintenance. (Installation, repair and maintenance only by qualified persons).
- Use only original parts for repairs or maintenance.
- Use the fixture only indoors. Don't use the fixture in humid or wet areas.
- Use only suitable light sources indicated on the label.

Make sure you have at least as much space in your (false) ceiling. It is very important to give enough air cooling to avoid any damage.

The manufacturer accepts no liability for any injuries or damages resulting from the incorrect use or installation of the fixture. Any operation performed on the fixture that is not in accordance with instructions will void manufacturer's warranty. If you find any damage to the electrical parts, please ask a qualified electrician to replace it.

Maintenance is preservation:

A good preservation of the fixture is highly dependent on environmental factors and maintenance. We cannot exercise any influence on this.

- Make sure that the mains voltage is switched off before you begin.
- Do not use strong, chemicals or abrasive cleaners.

"No rights can be derived from the information provided on this Instruction Manual. Information on the Instruction Manual has been compiled with the utmost care and is updated on a continuous basis. Nevertheless Maretti cannot guarantee that all information is free of errors, complete or fully up to date."

11.1811.COLOUR.A
 11.1812.COLOUR.A
 11.1813.COLOUR.A
 11.1814.COLOUR.A

SQUARE TRIMLESS AR111

with adjustable installation kit
 3/5

MOUNTING INSTRUCTIONS IN LOWERED CEILING

ADJUSTMENT KIT

Crossing view
 this part above plaster ceiling

Maximum
 Ceiling 30.00

Minimum
 Ceiling 3.00

⚠ We recommend to hold the plug and play cable like this during the installation.

L:156xB:156
 xH:100mm

L:300xB:156
 xH:100mm

L:444xB:156
 xH:100mm

L:312xB:312
 xH:100mm



LET OP:

- Volg en bewaar deze gebruiksaanwijzing.
- Zorg ervoor dat de netspanning uitgeschakeld is voor installatie, reparatie of onderhoud. (Installatie, reparatie en onderhoud uitsluitend door gekwalificeerde personen).
- Voor reparatie of onderhoud uitsluitend originele delen gebruiken.
- Gebruik het armatuur alleen binnenshuis. Het armatuur niet in vochtige of natte ruimte gebruiken.
- Uitsluitend op het etiket aangegeven lichtbronnen gebruiken.

Wanneer u een spot inbouwt moet u rekening houden met de warmte en dus rekening houden met extra inbouwruimte rond je armatuur om eventuele schade te voorkomen.

De fabrikant aanvaardt geen enkele aansprakelijkheid voor letsel of schade als gevolg van een verkeerde toepassing van het armatuur. De fabrikant aanvaardt geen garantie in geval van het niet behandelen van de lampen volgens de richtlijnen van de fabrikant. Als er schade aan elektrische onderdelen te vinden zijn, vraag dan een electricien om het te vervangen.

Onderhoud is behoud:

Een goede instandhouding van het armatuur is sterk afhankelijk van omgevings- en onderhoudsfactoren. Hierop kunnen wij geen invloed uitoefenen.

- Schakel voor de zekerheid de elektriciteit uit!
- Gebruik geen bijtende, chemische middelen of schurende schoonmaakmiddelen.

NOTE:

- Follow and keep this instructions manual.
- Make sure that the mains voltage is switched off for installation, reparation or maintenance. (Installation, reparation and maintenance only by qualified persons).
- Use only original parts for repairs or maintenance.
- Use the fixture only indoors. Don't use the fixture in humid or wet areas.
- Use only suitable light sources indicated on the label.

Make sure you have at least as much space in your (false) ceiling. It is very important to give enough air cooling to avoid any damage.

The manufacturer accepts no liability for any injuries or damages resulting from the incorrect use or installation of the fixture. Any operation performed on the fixture that is not in accordance with instructions will void manufacturer's warranty. If you find any damage to the electrical parts, please ask a qualified electrician to replace it.

Maintenance is preservation:

A good preservation of the fixture is highly dependent on environmental factors and maintenance. We cannot exercise any influence on this.

- Make sure that the mains voltage is switched off before you begin.
- Do not use strong, chemicals or abrasive cleaners.

"No rights can be derived from the information provided on this Instruction Manual. Information on the Instruction Manual has been compiled with the utmost care and is updated on a continuous basis. Nevertheless Maretti cannot guarantee that all information is free of errors, complete or fully up to date."

- 11.1811.COLOUR.A
- 11.1812.COLOUR.A
- 11.1813.COLOUR.A
- 11.1814.COLOUR.A

SQUARE TRIMLESS AR111

with adjustable installation kit
4/5

MEASUREMENTS: CONCRETE BOXES (note: The boxes can't be ordered separately; as they are produced on order basis, price on request). See next page for more about concrete ceiling.

Measurements for the SQUARE TRIMLESS 1 LIGHT

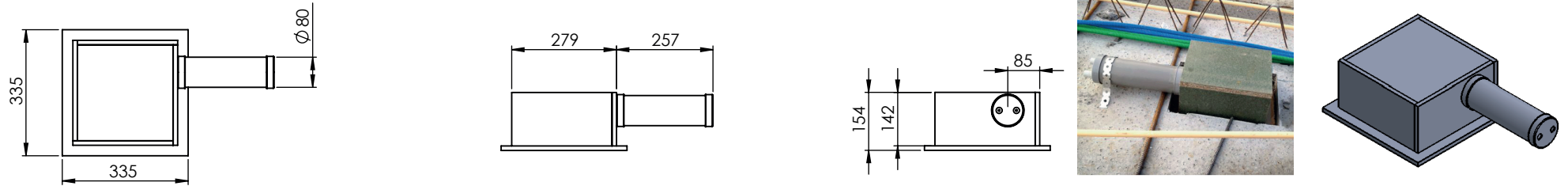

Measurements for the SQUARE TRIMLESS 2 & 3 LIGHTS

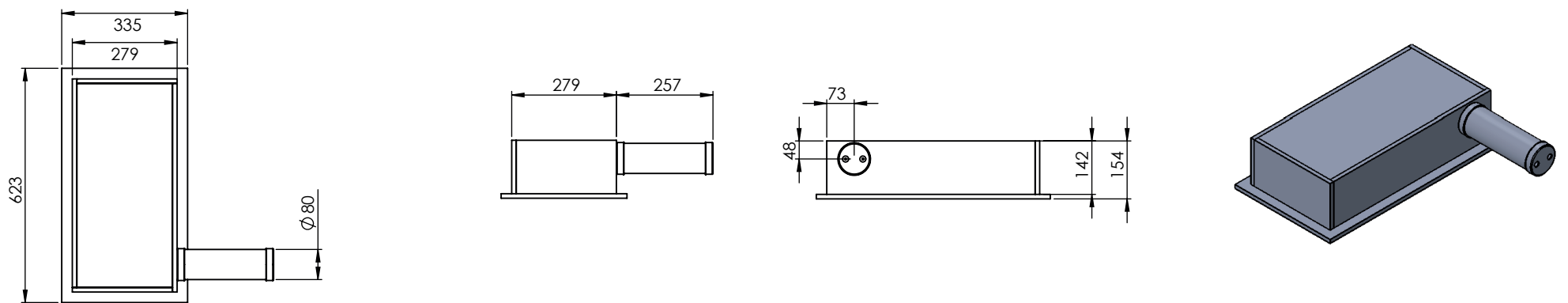

Measurements for the SQUARE TRIMLESS 4 LIGHTS

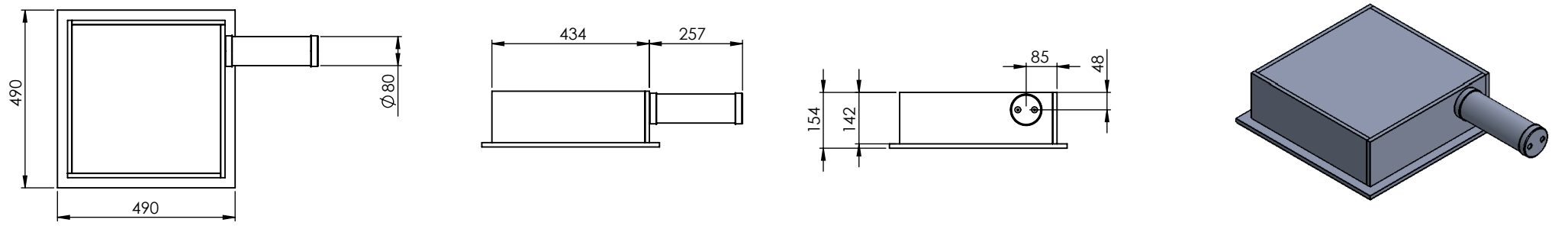

LET OP:
Lees A.U.B. aandachtig de veiligheidsvoorschriften op pagina 3

NOTE:
Please read carefully the safety warnings in page 3

"No rights can be derived from the information provided on this Instruction Manual. Information on the Instruction Manual has been compiled with the utmost care and is updated on a continuous basis. Nevertheless Maretti cannot guarantee that all information is free of errors, complete or fully up to date."

11.1811.COLOUR.A
 11.1812.COLOUR.A
 11.1813.COLOUR.A
 11.1814.COLOUR.A

SQUARE TRIMLESS AR111

with adjustable installation kit
 5/5

MOUNTING INSTRUCTIONS IN CONCRETE CEILING

1

2

Use the concrete stamp to support the box. You can remove the concrete stamp when the concrete is completely dried out

Concrete stamp

3

Remove the construction

4

5

6

Put the driver into the PVC tube.

Hight depends on the hight of the stucco

7

PLASTER

NOTE: See page 3 of the instruction manual for mouting instructions of the fixture and the adjustment kit



LET OP:
 Lees A.U.B. aandachtig de veiligheidsvoorschriften op pagina 3

NOTE:
 Please read carefully the safety warnings in page 3

"No rights can be derived from the information provided on this Instruction Manual. Information on the Instruction Manual has been compiled with the utmost care and is updated on a continuous basis. Nevertheless Maretti cannot guarantee that all information is free of errors, complete or fully up to date."