



Maretti Lighting  
Bolderweg 7

1332 AX Almere  
the Netherlands

T +31 (0) 36 532 66 12  
F +31 (0) 36 532 17 35

E info@halanederland.com  
W www.halanederland.com

Maretti Lighting is well-known in the World of interior design. In businesses, homes, store chains, and hospitality facilities all over the world, Maretti is an unmistakable presence with its project lighting that does more than just provide light. We make lighting an essential part of the interior. Maretti stands for stylish top quality and trendsetting design, modern, timeless and most of all, original.

Maretti Lighting works with all the top brands in the lighting industry, but we are especially notable for our own large product line and introduce our own brand name "Maretti". Our production team distinguishes itself time and time again with unique innovations from our own atelier and therefore our projects exude an entirely unique identity.

© Copyright Maretti Projectverlichting.

Our IM was made with the greatest of care. Nevertheless, the colours displayed in the IM may differ slightly from the real colours because of the printing process. Colour, size and range are subject to change. Nothing from this IM may be copied, reproduced and/or published by print, photocopy or in any other way without Maretti Lighting's written permission. All product and design copyrights belong to Maretti Lighting.

**GUARANTEE TERMS AND CONDITIONS**

The other party should inspect the delivered items immediately upon receipt with regard to its soundness. Entitlements to repair or replacement only exist if the other party

- In the case of visible defects, informs MPV of them immediately.

- In the case of defects that are not visible, informs MPV in writing of the defects, within 2 working days after the day the defects were found, or in all reason could have been found and furthermore demonstrates that the MPV instructions for use, maintenance and operation were followed, whilst the defects are not the consequence of normal wear and tear, misuse, negligence, accident, exceeding the limits prescribed by the MPV or by the legal safety regulations, or, in the case of a repair or change without MPV's consent or the consent of its recognised repairer, there will be no entitlement to repairs or replacement. The parts that have to be replaced must be made available free of charge to MPV. Noncompliance by the other party to one or more of its obligations will release MPV of all its guarantee obligations. In the case of assembly of the other party's own products by Maretti, MPV will release itself from all guarantee stipulations. Moreover, our general delivery terms and conditions are applicable. These can be obtained from Maretti or can be downloaded from [www.maretti.com](http://www.maretti.com)

The installation must be done by a competent installer. Maretti recommends that your (outside) lighting and fixture annually to be inspected and maintain. For maintenance advice: [www.maretti.com/maintenance.html](http://www.maretti.com/maintenance.html)

D: Für garantiebdingungen bitte lesen sie unsere website [www.maretti.com](http://www.maretti.com)  
E: Consulte nuestro sitio web para los condiciones de garantia [www.maretti.com](http://www.maretti.com)  
FR: Consultez notre site web pour les conditions de garantie [www.maretti.com](http://www.maretti.com)  
NL: Voor garantievvoorwaarden zie onze website [www.maretti.com](http://www.maretti.com)

**60.0180.Colour | DOT SUSPENDED**



STANDARD MODELS AVAILABLE IN 4 COLOURS



OTHER COLORS AVAILABLE ON REQUEST AND AT AN ADDITIONAL COST.

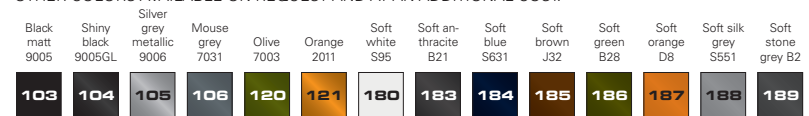

230V	VOLTAGE	20	IP				
MAX. 75W	WATTAGE	✓	INDOOR				
	BULB NOT INCLUDED	CE	CE MARK				
E27	SOCKET						

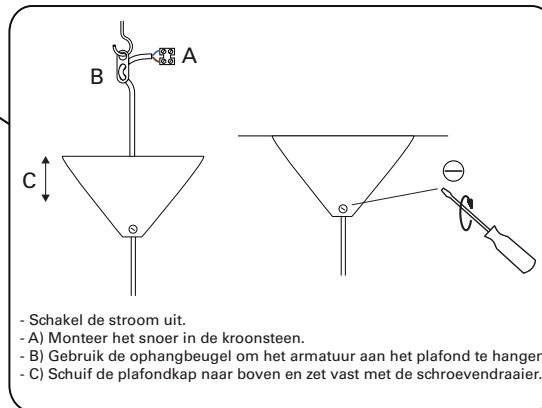
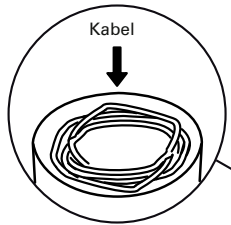
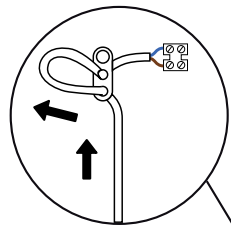
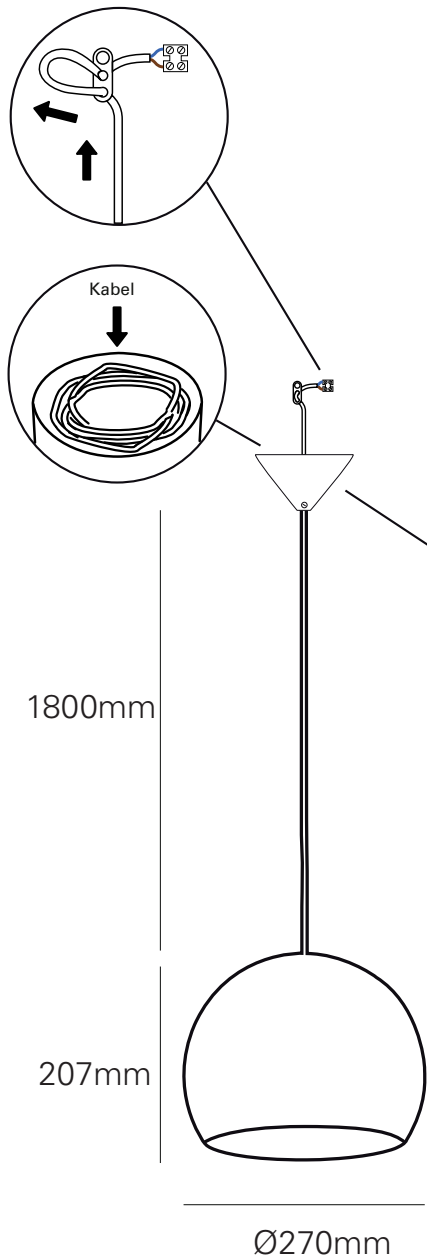

#### Algemene veiligheidsvoorschriften:

- Volg en bewaar deze gebruiksaanwijzing.
- Schakel altijd eerst de stroom uit voor installatie of onderhoud.
- Gebruik het armatuur alleen binnenshuis.
- Hang de lamp nooit op in vochtige of natte ruimte.

Dit armatuur is dubbel geïsoleerd en hoeft niet geaard te worden.  
De draden zijn gekleurd in overeenstemming met de volgende betekenis:

Blauw = null of neutral  
Bruin = phase of spanningsdraad

- Aansluiten aan de netspanningdraden
- Verbinden aan de netspanningdraden d.m.v. een kroonsteentje.
- Raadpleeg een vakman in het geval van twijfel.

De fabrikant aanvaardt geen enkele aansprakelijkheid voor letsel of schade als gevolg van een verkeerde toepassing van het armatuur.

Lampen van ruw onbehandeld aluminium (kleurnummer 107) kunnen onderhevig zijn aan krassen en beschadigingen uit het productieproces.

Hala Lighting

Art.60.0180



This luminaire is compatible with bulbs of the energy classes:

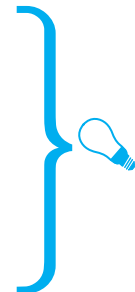
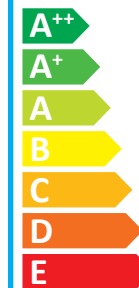

874/2012

